

DENON

AV SURROUND RECEIVER

AVR-1311

Owner's Manual

Manuel de l'Utilisateur

Manuale delle istruzioni

Manual del usuario

Kullanım Kılavuzu



Simple version
Version simplifiée
Versione semplice
Versión sencilla
Basit versiyon

3

Basic version
Version basique
Versione base
Versión básica
Temel versiyon

11

Advanced version
Version avancée
Versione avanzata
Versión avanzada
Gelişmiş versiyon

26

Information
"Part names and functions"
(page 41)

40

Informations
"Nomenclature et fonctions" (page 41)

Informazioni
"Nomi delle parti e funzioni" (pagina 41)

Información
"Nombres y funciones de las piezas" (página 41)

Bilgi
"Parça isimleri ve fonksiyonları" (sayfa 41)

SAFETY PRECAUTIONS



CAUTION
RISK OF ELECTRIC SHOCK
DO NOT OPEN



CAUTION:
TO REDUCE THE RISK OF ELECTRIC SHOCK, DO NOT REMOVE COVER (OR BACK). NO USER-SERVICEABLE PARTS INSIDE. REFER SERVICING TO QUALIFIED SERVICE PERSONNEL.

 The lightning flash with arrowhead symbol, within an equilateral triangle, is intended to alert the user to the presence of uninsulated "dangerous voltage" within the product's enclosure that may be of sufficient magnitude to constitute a risk of electric shock to persons.

 The exclamation point within an equilateral triangle is intended to alert the user to the presence of important operating and maintenance (servicing) instructions in the literature accompanying the appliance.

WARNING:
TO REDUCE THE RISK OF FIRE OR ELECTRIC SHOCK, DO NOT EXPOSE THIS APPLIANCE TO RAIN OR MOISTURE.

IMPOTANT SAFETY INSTRUCTIONS

1. Read these instructions.
2. Keep these instructions.
3. Heed all warnings.
4. Follow all instructions.
5. Do not use this apparatus near water.
6. Clean only with dry cloth.
7. Do not block any ventilation openings.
Install in accordance with the manufacturer's instructions.
8. Do not install near any heat sources such as radiators, heat registers, stoves, or other apparatus (including amplifiers) that produce heat.
9. Protect the power cord from being walked on or pinched particularly at plugs, convenience receptacles, and the point where they exit from the apparatus.
10. Only use attachments/accessories specified by the manufacturer.
11. Use only with the cart, stand, tripod, bracket, or table specified by the manufacturer, or sold with the apparatus. When a cart is used, use caution when moving the cart/apparatus combination to avoid injury from tip-over.
12. Unplug this apparatus during lightning storms or when unused for long periods of time.
13. Refer all servicing to qualified service personnel. Servicing is required when the apparatus has been damaged in any way, such as power-supply cord or plug is damaged, liquid has been spilled or objects have fallen into the apparatus, the apparatus has been exposed to rain or moisture, does not operate normally, or has been dropped.
14. Batteries shall not be exposed to excessive heat such as sunshine, fire or the like.



NOTE ON USE / HINWEISE ZUM GEBRAUCH / OBSERVATIONS RELATIVES A L'UTILISATION

WARNINGS	WARNHINWEISE	AVERTISSEMENTS
<ul style="list-style-type: none"> • Avoid high temperatures. Allow for sufficient heat dispersion when installed in a rack. • Handle the power cord carefully. Hold the plug when unplugging the cord. • Keep the unit free from moisture, water, and dust. • Unplug the power cord when not using the unit for long periods of time. • Do not obstruct the ventilation holes. • Do not let foreign objects into the unit. • Do not let insecticides, benzene, and thinner come in contact with the unit. • Never disassemble or modify the unit in any way. • Ventilation should not be impeded by covering the ventilation openings with items, such as newspapers, tablecloths or curtains. • Naked flame sources such as lighted candles should not be placed on the unit. • Observe and follow local regulations regarding battery disposal. • Do not expose the unit to dripping or splashing fluids. • Do not place objects filled with liquids, such as vases, on the unit. • Do not handle the mains cord with wet hands. • When the switch is in the OFF position, the equipment is not completely switched off from MAINS. • The equipment shall be installed near the power supply so that the power supply is easily accessible. 	<ul style="list-style-type: none"> • Vermeiden Sie hohe Temperaturen. Beachten Sie, dass eine ausreichende Belüftung gewährleistet wird, wenn das Gerät auf ein Regal gestellt wird. • Gehen Sie vorsichtig mit dem Netzkabel um. Halten Sie das Kabel am Stecker, wenn Sie den Stecker herausziehen. • Halten Sie das Gerät von Feuchtigkeit, Wasser und Staub fern. • Wenn das Gerät längere Zeit nicht verwendet werden soll, trennen Sie das Netzkabel vom Netzstecker. • Decken Sie den Lüftungsbereich nicht ab. • Lassen Sie keine fremden Gegenstände in das Gerät kommen. • Lassen Sie das Gerät nicht mit Insektiziden, Benzin oder Verdünnungsmitteln in Berührung kommen. • Versuchen Sie niemals das Gerät auseinander zu nehmen oder zu verändern. • Die Belüftung sollte auf keinen Fall durch das Abdecken der Belüftungsöffnungen durch Gegenstände wie beispielsweise Zeitungen, Tischtücher, Vorhänge o. Ä. behindert werden. • Auf dem Gerät sollten keinerlei direkte Feuerquellen wie beispielsweise angezündete Kerzen aufgestellt werden. • Bitte beachten Sie bei der Entsorgung der Batterien die örtlich geltenden Umweltbestimmungen. • Das Gerät sollte keiner tropfenden oder spritzenden Flüssigkeit ausgesetzt werden. • Auf dem Gerät sollten keine mit Flüssigkeit gefüllten Behälter wie beispielsweise Vasen aufgestellt werden. • Das Netzkabel nicht mit feuchten oder nassen Händen anfassen. • Wenn der Schalter ausgeschaltet ist (OFF-Position), ist das Gerät nicht vollständig vom Stromnetz (MAINS) abgetrennt. • Das Gerät sollte in der Nähe einer Netzsteckdose aufgestellt werden, damit es leicht an das Stromnetz angeschlossen werden kann. 	<ul style="list-style-type: none"> • Eviter des températures élevées. Tenir compte d'une dispersion de chaleur suffisante lors de l'installation sur une étagère. • Manipuler le cordon d'alimentation avec précaution. Tenir la prise lors du débranchement du cordon. • Protéger l'appareil contre l'humidité, l'eau et la poussière. • Débrancher le cordon d'alimentation lorsque l'appareil n'est pas utilisé pendant de longues périodes. • Ne pas obstruer les trous d'aération. • Ne pas laisser des objets étrangers dans l'appareil. • Ne pas mettre en contact des insecticides, du benzène et un diluant avec l'appareil. • Ne jamais démonter ou modifier l'appareil d'une manière ou d'une autre. • Ne pas recouvrir les orifices de ventilation avec des objets tels que des journaux, nappes ou rideaux. Cela entraverait la ventilation. • Ne jamais placer de flamme nue sur l'appareil, notamment des bougies allumées. • Veillez à respecter les lois en vigueur lorsque vous jetez les piles usagées. • L'appareil ne doit pas être exposé à l'eau ou à l'humidité. • Ne pas poser d'objet contenant du liquide, par exemple un vase, sur l'appareil. • Ne pas manipuler le cordon d'alimentation avec les mains mouillées. • Lorsque l'interrupteur est sur la position OFF, l'appareil n'est pas complètement déconnecté du SECTEUR (MAINS). • L'appareil sera installé près de la source d'alimentation, de sorte que cette dernière soit facilement accessible.

NOTE SULL'USO / NOTAS SOBRE EL USO / ALVORENS TE GEBRUIKEN / OBSERVERA ANGÅENDE ANVÄNDNINGEN / ЗАМЕЧАНИЯ ПО ЭКСПЛУАТАЦИИ / WSKAZÓWKI DOTYCZĄCE OBSŁUGI / KULLANIM NOTLARI

AVVERTENZE	ADVERTENCIAS	WAARSCHUWINGEN	VARNINGAR	ПРЕДОСТЕРЕЖЕНИЕ	OSTRZEŻENIE	UYARI
<ul style="list-style-type: none"> • Evitate di esporre l'unità a temperature elevate. Assicuratevi che vi sia un'adeguata dispersione del calore quando installate l'unità in un mobile per componenti audio. • Manneggiate il cavo di alimentazione con attenzione. Tenete ferma la spina quando scollegate il cavo dalla presa. • Tenete l'unità lontana dall'umidità, dall'acqua e dalla polvere. • Scollegate il cavo di alimentazione quando prevedete di non utilizzare l'unità per un lungo periodo di tempo. • Non coprite i fori di ventilazione. • Non inserite corpi estranei all'interno dell'unità. • Assicuratevi che l'unità non entri in contatto con insetticidi, benzolo o solventi. • Non smontate né modificate l'unità in alcun modo. • Le aperture di ventilazione non devono essere ostruite coprendole con oggetti, quali giornali, tovaglie, tende e così via. • Non posizionate sull'unità fi amme libere, come ad esempio candele accese. • Prestate attenzione agli aspetti legati alla tutela dell'ambiente nello smaltimento delle batterie. • L'apparecchiatura non deve essere esposta a gocciolii o spruzzi. • Non posizionate sull'unità alcun oggetto contenente liquidi, come ad esempio i vasi. • Non toccare il cavo di alimentazione con le mani bagnate. • Quando l'interruttore è nella posizione OFF, l'apparecchiatura non è completamente scollegata da MAINS. • L'apparecchio va installato in prossimità della fonte di alimentazione, in modo che quest'ultima sia facilmente accessibile. 	<ul style="list-style-type: none"> • Evite altas temperaturas. Permite la suficiente dispersión del calor cuando está instalado en la consola. • Maneje el cordón de energía con cuidado. Sostenga el enchufe cuando desconecte el cordón de energía. • Mantenga el equipo libre de humedad, agua y polvo. • Desconecte el cordón de energía cuando no utilice el equipo por mucho tiempo. • No obstruya los orificios de ventilación. • No deje objetos extraños dentro del equipo. • No permita el contacto de insecticidas, gasolina y diluyentes con el equipo. • Nunca desarme o modifique el equipo de ninguna manera. • La ventilación no debe quedar obstruida por haberse cubierto las aperturas con objetos como periódicos, manteles o cortinas. • No deberán colocarse sobre el aparato fuentes inflamables sin protección, como velas encendidas. • A la hora de deshacerse de las pilas, respete la normativa para el cuidado del medio ambiente. • No exponer el aparato al goteo o salpicaduras cuando se utilice. • No colocar sobre el aparato objetos llenos de líquido, como jarras. • No maneje el cable de alimentación con las manos mojadas. • Cuando el interruptor está en la posición OFF, el equipo no está completamente desconectado de la alimentación MAINS. • El equipo se instalará cerca de la fuente de alimentación de manera que resulte fácil acceder a ella. 	<ul style="list-style-type: none"> • Vermijd hoge temperaturen. Zorg er bij installatie in een audiorack voor, dat de door het toestel geproduceerde warmte goed kan worden afgevoerd. • Hanteer het netsnoer voorzichtig. Houd het snoer bij de stekker vast wanneer deze moet worden aange- of losgekoppeld. • Laat geen vochtigheid, water of stof in het apparaat binnendringen. • Neem altijd het netsnoer uit het stopcontact wanneer het apparaat gedurende een lange periode niet wordt gebruikt. • De ventilatieopeningen mogen niet worden geblokkeerd. • Laat geen vreemde voorwerpen in dit apparaat vallen. • Voorkom dat insecticiden, benzeen of verfverdunner met dit toestel in contact komen. • Dit toestel mag niet gedemonteerd of aangepast worden. • De ventilatie mag niet worden belemmerd door de ventilatieopeningen af te dekken met bijvoorbeeld kranten, een tafelkleed of gordijnen. • Plaats geen open vlammen, bijvoorbeeld een brandende kaars, op het apparaat. • Houd u steeds aan de milieuvoorschriften wanneer u gebruikte batterijen wegdoet. • Stel het apparaat niet bloot aan druppels of spatten. • Plaats geen voorwerpen gevuld met water, bijvoorbeeld een vaas, op het apparaat. • Raak het netsnoer niet met natte handen aan. • Als de schakelaar op OFF staat, is het apparaat niet volledig losgekoppeld van de netspanning (MAINS). • De apparatuur wordt in de buurt van het stopcontact geïnstalleerd, zodat dit altijd gemakkelijk toegankelijk is. 	<ul style="list-style-type: none"> • Undvik höga temperaturer. Se till att det finns möjlighet till god värmeavledning vid montering i ett rack. • Hantera nätkabeln varsamt. Håll i kabeln när den kopplas från el-uttaget. • Utsätt inte apparaten för fukt, vatten och damm. • Koppla loss nätkabeln om apparaten inte kommer att användas i lång tid. • Täpp inte till ventilationsöppningarna. • Se till att främmande föremål inte tränger in i apparaten. • Se till att inte insektsmedel på spraybruk, bensen och thinner kommer i kontakt med apparatens hölje. • Ta inte isär apparaten och försök inte bygga om den. • Ventilationen bör inte förhindras genom att täcka för ventilationsöppningarna med föremål såsom tidningar, bordsdukar eller gardiner. • Placera inte öppen eld, t.ex. tända ljus, på apparaten. • Tänk på miljöaspekterna när du bortskaffar batterier. • Apparaten får inte utsättas för vätska. • Placera inte föremål fyllda med vätska, t.ex. vaser, på apparaten. • Hantera inte nåtsladden med våta händer. • Även om strömbrytaren står i det avstängda läget OFF, så är utrustningen inte helt bortkopplad från det elektriska nätet (MAINS). • Utrustningen ska vara installerad nära strömuttaget så att strömförsörjningen är lätt att tillgå. 	<ul style="list-style-type: none"> • Избегайте высоких температур. Учитывайте значительное распределение тепла при установке устройства на полку. • Будьте осторожны при включении/отключении кабеля питания. • При включении/отключении кабеля питания беритесь за вилку. • Не подвергайте устройство воздействию влаги, воды и пыли. • Если устройство не будет использоваться в течение длительного времени, отключите кабель питания от сети. • Не закрывайте вентиляционные отверстия. • Следите, чтобы посторонние предметы не попадали внутрь устройства. • Предохраняйте устройство от воздействия ядохимикатов, бензина и растворителей. • Никогда не разбирайте и не модифицируйте устройство. • Не закрывайте вентиляционные отверстия такими предметами, как газеты, скатерти, шторы и др. • Не размещайте на поверхности аппарата источники открытого огня, например свечи. • Обратите внимание на экологические аспекты утилизации батарей питания. • Следите, чтобы на устройство не проливалась вода. • Не располагайте емкости, в которых содержится вода, на устройстве. • Не прикасайтесь к сетевому шнуру мокрыми руками. • Когда переключатель установлен в положение ВЫКЛ, оборудование не полностью отключено от СЕТИ ПИТАНИЯ. • Оборудование следует устанавливать возле источника питания, чтобы его можно было легко подключить. 	<ul style="list-style-type: none"> • Unikaj wysokich temperatur. Jeśli urządzenie jest ustawione w szafce, należy zapewnić odpowiednią cyrkulację powietrza. • Obchodź się ostrożnie z przewodem zasilającym. • Odłączając przewód z gniazda elektrycznego, trzymaj zawsze za wtyczkę. • Chroń urządzenie przed wilgocią, wodą i pyłem. • Odłącz przewód zasilający z sieci, jeśli urządzenie nie jest używane przez dłuższy czas. • Nie zakrywaj otworów wentylacyjnych. • Zwróć uwagę, aby do środka urządzenia nie dostały się żadne obce przedmioty. • Chroń urządzenie przed kontaktem z środkami owadobójczymi, benzyną oraz rozpuszczalnikiem. • Nie rozbieraj urządzenia oraz nie dokonuj w nim żadnych modyfikacji. • Nie należy ograniczać wentylacji urządzenia, np. poprzez zakrycie otworów wentylacyjnych gazetami, obrusem, zasłonami itp. • Na urządzeniu nie wolno stawiać żadnych źródeł otwartego ognia, np. zapalonych świec. • Przestrzegaj lokalnych przepisów dotyczących utylizacji baterii. • Chroń urządzenie przez zachłapaniem lub kąpieniem wszelkich cieczy. • Nie stawiaj na urządzeniu żadnych przedmiotów napełnionych wodą, np. wazonów. • Nie dotykaj przewodu zasilającego mokrymi rękoma. • Gdy wyłącznik znajduje się w położeniu OFF (wył.), urządzenie nie jest całkowicie odłączone od zasilania. • Urządzenie należy ustawić w pobliżu źródła zasilania, aby zapewnić do niego łatwy dostęp. 	<ul style="list-style-type: none"> • Yüksek sıcaklıklardan kaçınınız. Bir raf içinde kuruluysa yeterli ısı dağılımı olmasına dikkat ediniz. • Güç kablosunu dikkatli kullanınız. Kabloyu fişten çekerken prizden tutunuz. • Üniteyi nem, su ve tozdan uzak tutunuz. • Ünite uzun süre kullanılmayacaksa ünitenin kablosunu prizden çekiniz. • Havalandırma deliklerini kapatmayınız. • Üniteyi yabancı cisim girmesine izin vermeyiniz. • Böcek ilacı, benzen ve tiner gibi maddeleri üniteyle temas ettirmeyiniz. • Üniteyi asla hiçbir şekilde sökmeyiniz ve üzerinde değişiklik yapmayınız. • Havalandırma gazete, masa örtüsü, perde ve benzeri cisimlerle kapatılarak engellenmemelidir. • Yanan mum gibi açık alev kaynağı cisimleri üniteye yaklaştırmayınız. • Pillerin atılması ile ilgili yerel yasa ve düzenlemelere riayet ediniz. • Üniteyi, üzerine sıvı damlama veya sığrama ihtimali olan yerlerde bulundurmuyunuz. • Vazo gibi sıvıyla dolu cisimleri ünitenin üzerine koymayınız. • Mains kablosunu ıslak elle tutmayınız. • Sviç OFF (Kapalı) konumunda olduğunda, ekipman MAINS'ten tamamen kapatılamaz. • Ekipman güç kaynağının yakınlarını monte edilmelidir böylelikle güç kaynağına kolayca erişilebilir.

For EU countries

• DECLARATION OF CONFORMITY

We declare under our sole responsibility that this product, to which this declaration relates, is in conformity with the following standards: EN60065, EN55013, EN55020, EN61000-3-2 and EN61000-3-3.

Following the provisions of Low Voltage Directive 2006/95/EC and EMC Directive 2004/108/EC, the EC regulation 1275/2008 and its frame work Directive 2009/125/EC for Energy-related Products (ErP).

• ÜBEREINSTIMMUNGSERKLÄRUNG

Wir erklären unter unserer Verantwortung, daß dieses Produkt, auf das sich diese Erklärung bezieht, den folgenden Standards entspricht:

EN60065, EN55013, EN55020, EN61000-3-2 und EN61000-3-3.

Following the provisions of low voltage directive 2006/95/EC and EMC directive 2004/108/EC, the EC regulation 1275/2008 and its frame work directive 2009/125/EC for energy-related products (ErP).

• DECLARATION DE CONFORMITE

Nous déclarons sous notre seule responsabilité que l'appareil, auquel se réfère cette déclaration, est conforme aux standards suivants:

EN60065, EN55013, EN55020, EN61000-3-2 et EN61000-3-3.

Selon la directive 2006/95/EC concernant la basse tension et la directive CEM 2004/108/EC, la réglementation européenne 1275/2008 et la directive 2009/125/EC établissant un cadre de travail applicable aux produits liés à l'énergie (ErP).

• DICHIARAZIONE DI CONFORMITÀ

Dichiariamo con piena responsabilità che questo prodotto, al quale la nostra dichiarazione si riferisce, è conforme alle seguenti normative:

EN60065, EN55013, EN55020, EN61000-3-2 e EN61000-3-3.

Facendo seguito alle disposizioni della direttiva sul basso voltaggio 2006/95/EC alla direttiva EMC 2004/108/EC, alla norma EC 1275/2008 e alla relativa legge quadro 2009/125/EC in materia di prodotti alimentati ad energia (ErP).

QUESTO PRODOTTO E' CONFORME

AL D.M. 28/08/95 N. 548

• DECLARACIÓN DE CONFORMIDAD

Declaramos bajo nuestra exclusiva responsabilidad que este producto al que hace referencia esta declaración, está conforme con los siguientes estándares:

EN60065, EN55013, EN55020, EN61000-3-2 y EN61000-3-3.

De acuerdo con la directiva sobre baja tensión 2006/95/CE y la directiva sobre CEM 2004/108/CE, la normativa CE 1275/2008 y su directiva marco 2009/125/EC para productos relacionados con la energía (ErP).

• EENVORMIGHEIDSVERKLARING

Wij verklaren uitsluitend op onze verantwoordelijkheid dat dit product, waarop deze verklaring betrekking heeft, in overeenstemming is met de volgende normen:

EN60065, EN55013, EN55020, EN61000-3-2 en EN61000-3-3.

Volgens de voorzieningen van lage spanningsrichtlijn 2006/95/EC en EMC-richtlijn 2004/108/EC, de EU-richtlijn 1275/2008 en de kaderrichtlijn 2009/125/EC voor energieverbruikende producten (ErP).

• ÖVERENSSTÄMMELSESINTYG

Härmed intygas helt på eget ansvar att denna produkt, vilken detta intyg avser, uppfyller följande standarder:

EN60065, EN55013, EN55020, EN61000-3-2 och EN61000-3-3.

Uppfyller reglerna i lågspanningsdirektivet 2006/95/EC och EMC-direktivet 2004/108/EC, EU-förordningen 1275/2008 och ramverksdirektivet 2009/125/EC för energirelaterade produkter (ErP).

• СЕРТИФИКАТ СООТВЕТСТВИЯ

Мы гарантируем, что данный продукт, к которому прилагается данный сертификат, соответствует требованиям следующих стандартов:

EN60065, EN55013, EN55020, EN61000-3-2 и EN61000-3-3.

В соответствии с положениями директивы Директива по низковольтным устройствам 2006/95/EC и директивы EMC Directive 2004/108/EC, распоряжения EC 1275/2008 и директивы 2009/125/EC для энергопотребляющих устройств.

• DEKLARACJA ZGODNOŚCI

Deklarujemy z pełną odpowiedzialnością, że produkt, którego dotyczy niniejsza deklaracja, jest zgodny z następującymi normami: EN60065, EN55013, EN55020, EN61000-3-2 oraz EN61000-3-3.

Zgodnie z postanowieniami Dyrektywy niskonapięciowej 2006/95/EC oraz Dyrektywy EMC 2004/108/EC, Regulacji EC 1275/2008 oraz Dyrektywy ramowej 2009/125/EC dotyczącej urządzeń elektrycznych (ErP).

• UYGUNLUK BEYANI

Sorumluluğu tamamen kendimize ait olarak; işbu beyan konusu ürünün aşağıdaki standartlara uygun olduğunu beyan ederiz: EN60065, EN55013, EN55020, EN61000-3-2 ve EN61000-3-3.

Düşük Voltaj Yönergesi 2006/95/EC ve EMC Yönergesi 2004/108/EC'nin, EC yönetmeliği 1275/2008'in ve Enerji ile ilgili Ürünlerle ilişkin (ErP) çerçeve Yönerge 2009/125/EC'nin hükümlerine uygundur.

DENON EUROPE
Division of D&M Germany GmbH
An der Kleinbahn 18, Nettetal,
D-41334 Germany

CAUTION:

To completely disconnect this product from the mains, disconnect the plug from the wall socket outlet.

The mains plug is used to completely interrupt the power supply to the unit and must be within easy access by the user.

VORSICHT:

Um dieses Gerät vollständig von der Stromversorgung abzutrennen, ziehen Sie bitte den Stecker aus der Wandsteckdose.

Der Netzstecker wird verwendet, um die Stromversorgung zum Gerät völlig zu unterbrechen; er muss für den Benutzer gut und einfach zu erreichen sein.

PRECAUTION:

Pour déconnecter complètement ce produit du courant secteur, débranchez la prise de la prise murale.

La prise secteur est utilisée pour couper complètement l'alimentation de l'appareil et l'utilisateur doit pouvoir y accéder facilement.

ATTENZIONE:

Per scollegare completamente questo prodotto dalla rete di alimentazione elettrica, scollegare la spina dalla relativa presa a muro.

La spina di rete viene utilizzata per interrompere completamente l'alimentazione all'unità e deve essere facilmente accessibile all'utente.

PRECAUCIÓN:

Para desconectar completamente este producto de la alimentación eléctrica, desconecte el enchufe del enchufe de la pared.

El enchufe de la alimentación eléctrica se utiliza para interrumpir por completo el suministro de alimentación eléctrica a la unidad y debe de encontrarse en un lugar al que el usuario tenga fácil acceso.

WAARSCHUWING:

Om de voeding van dit product volledig te onderbreken moet de stekker uit het stopcontact worden getrokken.

De netstekker wordt gebruikt om de stroomtoevoer naar het toestel volledig te onderbreken en moet voor de gebruiker gemakkelijk bereikbaar zijn.

FÖRSIKTIHETSMÅTT:

Koppla loss stickproppen från eluttaget för att helt skilja produkten från nätet. Stickproppen används för att helt bryta strömförsörjningen till apparaten, och den måste vara lättillgänglig för användaren.

ОСТОРОЖНО:

Для того чтобы полностью отключить данный продукт от сети, выньте штепсельную вилку кабеля питания из розетки.

При установке данного продукта убедитесь в том, что используемая розетка находится в зоне досягаемости.

UWAGA:

W celu całkowitego odłączenia tego urządzenia od zasilania, należy wyjąć wtyczkę z gniazda elektrycznego.

Przewód zasilający umożliwia całkowite odłączenie dopływu zasilania do urządzenia i musi być łatwo dostępny dla użytkownika.

DIKKAT:

Ürünün elektrikle bağlantısını tamamen kesmek için fişi, duvardaki prizden çekiniz.

Elektrik prizi, cihaza gelen elektriği bütünüyle kesmek için kullanılmakta olup kullanıcının kolayca erişebileceği bir yerde olmalıdır.

A NOTE ABOUT RECYCLING:

This product's packaging materials are recyclable and can be reused. Please dispose of any materials in accordance with the local recycling regulations.

When discarding the unit, comply with local rules or regulations.

Batteries should never be thrown away or incinerated but disposed of in accordance with the local regulations concerning battery disposal.

This product and the supplied accessories, excluding the batteries, constitute the applicable product according to the WEEE directive.

HINWEIS ZUM RECYCLING:

Das Verpackungsmaterial dieses Produktes ist zum Recyceln geeignet und kann wieder verwendet werden. Bitte entsorgen Sie alle Materialien entsprechend der örtlichen Recycling-Vorschriften.

Beachten Sie bei der Entsorgung des Gerätes die örtlichen Vorschriften und Bestimmungen.

Die Batterien dürfen nicht in den Hausmüll geworfen oder verbrannt werden; bitte entsorgen Sie die Batterien gemäß der örtlichen Vorschriften.

Dieses Produkt und das im Lieferumfang enthaltene Zubehör (mit Ausnahme der Batterien!) entsprechen der WEEE-Direktive.

UNE REMARQUE CONCERNANT LE RECYCLAGE:

Les matériaux d'emballage de ce produit sont recyclables et peuvent être réutilisés. Veuillez disposer des matériaux conformément aux lois sur le recyclage en vigueur.

Lorsque vous mettez cet appareil au rebut, respectez les lois ou réglementations en vigueur.

Les piles ne doivent jamais être jetées ou incinérées, mais mises au rebut conformément aux lois en vigueur sur la mise au rebut des piles.

Ce produit et les accessoires inclus, à l'exception des piles, sont des produits conformes à la directive DEEE.

NOTA RELATIVA AL RICICLAGGIO:

I materiali di imballaggio di questo prodotto sono riutilizzabili e riciclabili. Smaltire i materiali conformemente alle normative locali sul riciclaggio.

Per lo smaltimento dell'unità, osservare le normative o le leggi locali in vigore.

Non gettare le batterie, né incenerirle, ma smaltirle conformemente alla normativa locale sui rifiuti chimici.

Questo prodotto e gli accessori inclusi nell'imballaggio sono applicabili alla direttiva RAEE, ad eccezione delle batterie.

ACERCA DEL RECICLAJE:

Los materiales de embalaje de este producto son reciclables y se pueden volver a utilizar. Disponga de estos materiales siguiendo los reglamentos de reciclaje de su localidad.

Cuando se deshaga de la unidad, cumpla con las reglas o reglamentos locales.

Las pilas nunca deberán tirarse ni incinerarse. Deberá disponer de ellas siguiendo los reglamentos de su localidad relacionados con los desperdicios químicos.

Este producto junto con los accesorios empaquetados es el producto aplicable a la directiva RAEE excepto pilas.

EEN AANTEKENING MET BETREKKING TOT DE RECYCLING:

Het inpakmateriaal van dit product is recycleerbaar en kan opnieuw gebruikt worden. Er wordt verzocht om zich van elk afvalmateriaal te ontdoen volgens de plaatselijke voorschriften.

Volg voor het wegdoen van de speler de voorschriften voor de verwijdering van wit- en bruingoed op.

Batterijen mogen nooit worden weggegooid of verbrand, maar moeten volgens de plaatselijke voorschriften betreffende chemisch afval worden verwijderd.

Op dit product en de meegeleverde accessoires, m.u.v. de batterijen is de richtlijn voor afgedankte elektrische en elektronische apparaten (WEEE) van toepassing.

OBSERVERA ANGÅENDE ÅTERVINNING:

Produktens emballage är återvinningsbart och kan återanvändas. Kassera det enligt lokala återvinningsbestämmelser.

När du kasserar enheten ska du göra det i överensstämmelse med lokala regler och bestämmelser.

Batterier får absolut inte kastas i soporna eller brännas. Kassera dem enligt lokala bestämmelser för kemiskt avfall.

Denna apparat och de tillbehör som levereras med den uppfyller gällande WEEE-direktiv, med undantag av batterierna.

ПРИМЕЧАНИЕ О ПЕРЕРАБОТКЕ:

Упаковочный материал данного продукта может быть переработан и повторно использован. Пожалуйста, сортируйте материалы в соответствии с местными требованиями переработки.

При утилизации определенных блоков соблюдайте местные правила утилизации.

Не выбрасывайте и не сжигайте батарейки, соблюдайте местные правила утилизации химических отходов.

Данный продукт и аксессуары в упаковке соответствуют директиве WEEE, исключая батарейки.

INFORMACJE DOTYCZĄCE RECYKLINGU:

Opakowanie urządzenia zostało wykonane z materiałów nadających się do wtórnego przetworzenia. Utylizację wszelkich materiałów należy przeprowadzić zgodnie z obowiązującymi lokalnymi przepisami dotyczącymi recyklingu.

Urządzenie należy zutylizować zgodnie z lokalnymi przepisami.

Baterii nie wolno wyrzucać do śmieci lub palić. Należy je zutylizować zgodnie z obowiązującymi zasadami dotyczącymi utylizacji baterii.

Niniejszy produkt oraz dostarczone wraz z nim akcesoria (oprócz baterii) stanowią właściwy produkt, zgodnie z dyrektywą WEEE.

GERİ DÖNÜŞÜME İLİŞKİN NOT:

Bu ürünün ambalajı geri dönüştürülebilir ve yeniden kullanılabilir niteliktedir. Materyalleri lütfen yerel geri dönüşüm yasa ve düzenlemelerine uygun biçimde atınız.

Üniteyi hurdaya çıkartırken mahalli yasa ve düzenlemelere riayet ediniz.

Piller asla rastgele atılmamalı ve yakılmamalı, bunun yerine pil atıklarına ilişkin mahalli yasa ve düzenlemelere uygun biçimde imha edilmelidir.

Bu ürün ve beraberinde gelen aksesuarları, pilleri hariç olmak kaydıyla, WEEE yönergesi uyarınca kapsam içi ürün niteliğindedir.



Pb

❑ **Cautions on installation / Vorsichtshinweise zur aufstellung /
Précautions d'installation / Precauzioni sull'installazione /
Emplazamiento de la instalación / Voorzorgsmaatregelen bij de installatie /
Försiktighet vid installationen / Меры предосторожности при установке /
Uwagi dotyczące instalacji /Montaj sırasında alınacak önlemler**

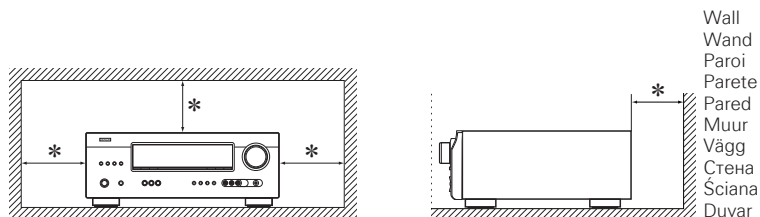

- * **For proper heat dispersal, do not install this unit in a confined space, such as a bookcase or similar enclosure.**
 - More than 0.3 m is recommended.
 - Do not place any other equipment on this unit.
- * **Stellen Sie das Gerät nicht an einem geschlossenen Ort, wie in einem Bücherregal oder einer ähnlichen Einrichtung auf, da dies eine ausreichende Belüftung des Geräts behindern könnte.**
 - Empfohlen wird über 0,3 m.
 - Keine anderen Gegenstände auf das Gerät stellen.
- * **Pour permettre la dissipation de chaleur requise, n'installez pas cette unité dans un espace confiné tel qu'une bibliothèque ou un endroit similaire.**
 - Une distance de plus de 0,3 m est recommandée.
 - Ne placez aucun matériel sur cet appareil.
- * **Per una dispersione adeguata del calore, non installare questa apparecchiatura in uno spazio ristretto, come ad esempio una libreria o simili.**
 - Si raccomanda una distanza superiore ai 0,3 m.
 - Non posizionare alcun altro oggetto o dispositivo su questo dispositivo.
- * **Para la dispersión del calor adecuadamente, no instale este equipo en un lugar confinado tal como una librería o unidad similar.**
 - Se recomienda dejar más de 0,3 m alrededor.
 - No coloque ningún otro equipo sobre la unidad.
- * **Plaats dit toestel niet in een kleine afgesloten ruimte, zoals een boekenkast e.d., omdat anders de warmte niet op gepaste wijze kan worden afgevoerd.**
 - Meer dan 0,3 m is aanbevolen.
 - Plaats geen andere apparatuur op het toestel.
- * **För att tillförsäkra god värmeavledning får utrustningen inte installeras i instängda utrymmen, som t.ex. en bokhylla eller liknande.**
 - Mer än 0,3 m rekommenderas.
 - Placera ingen annan utrustning ovanpå den här enheten.
- * **Чтобы не препятствовать отводу тепла, не устанавливайте блок в закрытое ограниченное пространство, например, в книжный шкаф и т.п.**
 - Рекомендуемое расстояние - не менее 0,3 м.
 - Не размещайте какое-либо другое оборудование на этом модуле.
- * **Ze względu na prawidłowe odprowadzanie ciepła, należy pamiętać o zachowaniu odpowiedniej przestrzeni wokół urządzenia. Nie należy umieszczać urządzenia w zamkniętych szafkach lub podobnych ograniczonych przestrzeniach.**
 - Zalecane jest zachowanie odległości powyżej 0,3 metra.
 - Nie należy stawiać na tym urządzeniu żadnego innego sprzętu.
- * **Isının düzgün şekilde dağılması için, bu üniteyi kitaplık veya benzeri alanlara yerleştirmeyiniz.**
 - 0,3 m'den daha fazlası önerilir.
 - Bu ünitenin üzerine başka herhangi bir ekipman yerleştirmeyin.

Getting started

Thank you for purchasing this DENON product. To ensure proper operation, please read these owner's manual carefully before using the product. After reading them, be sure to keep them for future reference.

Contents

Getting started	1
Accessories	1
About this manual	1
Features	2
Cautions on handling	2

Simple version (Simple setup guide)

Basic version

Connections	12
Important information	12
Connecting an HDMI-compatible device	12
Connecting a TV	13
Connecting a Blu-ray Disc player / DVD player	14
Connecting a set-top box (Satellite tuner/cable TV)	14
Connecting a digital camcorder	15
Connecting a portable player	15
Connecting a control dock for iPod	16
Connecting an antenna	16
Playback (Basic operation)	17
Important information	17
Playing a Blu-ray Disc player/DVD player	17
Playing a portable player	17
Playing an iPod®	18
Tuning in radio stations	20
Selecting a listening mode (Surround mode)	23
Standard playback	23
Multi channel stereo playback	25
Virtual playback	25
Stereo playback	25
Direct playback	25

Advanced version

Speaker installation/connection (Other than 5.1-channel)	27
Install	27
Connect	28
Playback (Advanced operation)	29
Convenient functions	29
How to make detailed settings	31
Menu map	31
Examples of front display	32
Input Setup	33
Option Setup	35
Adjusting the sound field effects	36
Information	39

Information

Part names and functions	41
Front panel	41
Display	41
Rear panel	42
Remote control unit	43
Other information	45
Trademark information	45
Surround	46
Explanation of terms	50
Troubleshooting	51
Resetting the microprocessor	53
Specifications	53

Accessories

Check that the following parts are supplied with the product.

① Owner's manual	1
② Service network list	1
③ Power cord (Cord length: Approx. 1.7 m)	1
④ Remote control unit (RC-1149)	1
⑤ R03/AAA batteries	2
⑥ AM loop antenna	1
⑦ FM indoor antenna	1

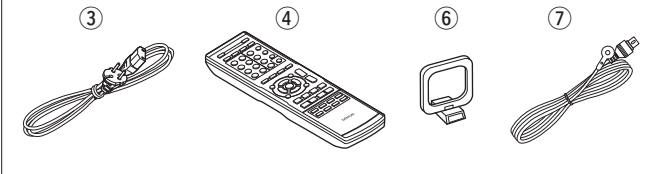

About this manual

Operation buttons

The operations described in this manual are based mainly on remote control operation.

Symbols



This symbol indicates a reference page on which related information is described.



This symbol indicates a supplementary information and tips for operations.

NOTE

This symbol indicates points to remember operations or function limitations.

Illustrations

Note that the illustrations in these instructions are for explanation purposes and may differ from the actual unit.

Features

Fully Discrete, identical quality and power for all 5 channels (110 W x 5ch)

The unit is equipped with a power amplifier that plays back high-fidelity sound in surround mode with equal quality and power for all channels, true to the original sound.

The power amplifier circuit adopts a discrete-circuit configuration that achieves high-quality surround sound play back.

Supports HDMI 1.4a with 3D, Deep Color and x.v.Color function

This unit can output 3D video signals input from a Blu-ray Disc player to a TV that supports a 3D system.

4-HDMI inputs and 1-output

The unit is equipped with 4 HDMI input connectors for connecting devices with HDMI connectors, such as a Blu-ray Disc player, game machine, HD video camera, etc.

High Definition Audio Support

The unit is equipped with a decoder which supports high-quality digital audio format for Blu-ray Disc players such as Dolby TrueHD, DTS-HD Master Audio, etc.

Dock connectivity for iPod® and network streaming

If an optional DENON control dock for iPod (ASD-3N, ASD-3W, ASD-51N or ASD-51W) is connected to this unit, you can listen to Internet radio or enjoy music and photos stored in your PC.

* An Internet connection environment is required.

Cautions on handling

• Before turning the power switch on

Check once again that all connections are correct and that there are no problems with the connection cables.

- Power is supplied to some of the circuitry even when the unit is set to the standby mode. When going on vacation or leaving home for long periods of time, be sure to unplug the power cord from the power outlet.

• About Condensation

If there is a major difference in temperature between the inside of the unit and the surroundings, condensation (dew) may form on the operating parts inside the unit, causing the unit not to operate properly.

If this happens, let the unit sit for an hour or two with the power turned off and wait until there is little difference in temperature before using the unit.

• Cautions on using mobile phones

Using a mobile phone near this unit may result in noise. If that occurs, move the mobile phone away from this unit when it is in use.

• Moving the unit

Turn off the power and unplug the power cord from the power outlet. Next, disconnect the connection cables to other system units before moving the unit.

• About Care

- Wipe the cabinet and control panel clean with a soft cloth.
- Follow the instructions when using a chemical cleaner.
- Benzene, paint thinner or other organic solvents as well as insecticide may cause material changes and discoloration if brought into contact with the unit, and should therefore not be used.

Simple version (Simple setup guide)

Here, we explain the entire setup procedure, from unboxing the unit to using it in a home theater.

Standard settings have been made for the speaker as default.

For optimum surround playback, adjustment of the distance of speakers and sound level of each channel, using the test tone, are required, depending on the environment for speakers to be used.

- Before connecting the unit, turn off the power to all devices.
- For operation of the connected devices, refer to the user manuals for each device.

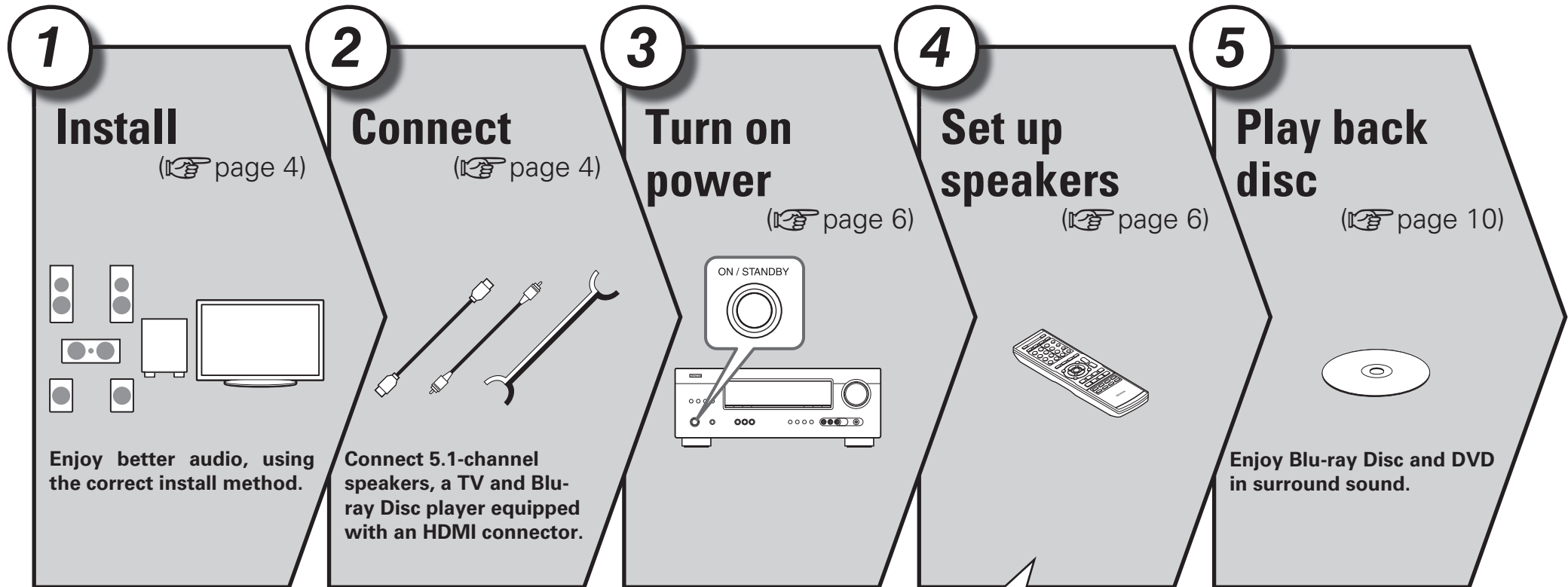

Set Up Speakers

Speaker Configuration

Bass Setting

Distance

Channel Level

Crossover Frequency

1 Install



This unit can perform 2.0/2.1 to 7.1-channel surround playback. Here, we explain setup using the example of 5.1-channel speaker playback.

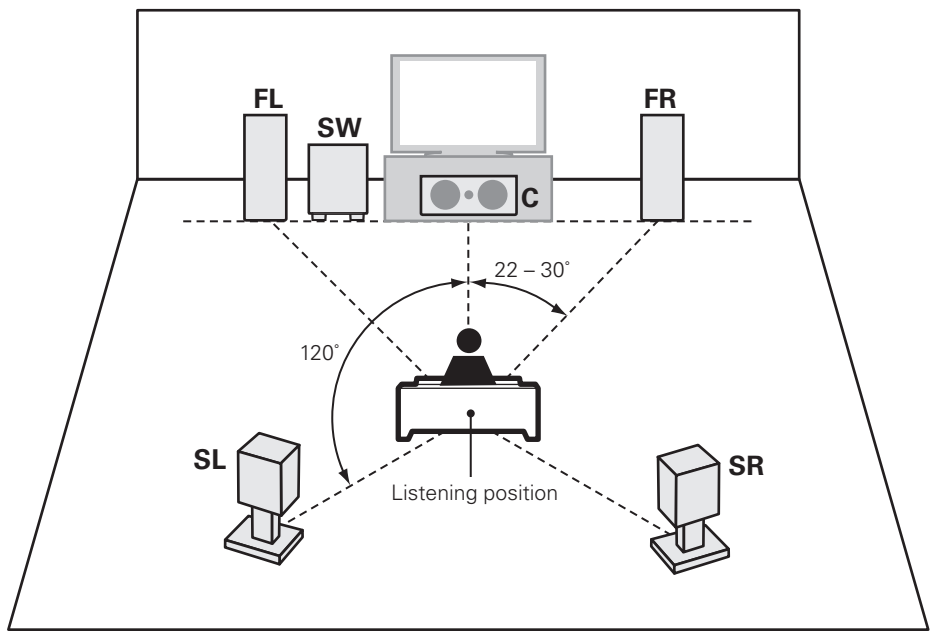

- FL** Front speaker (L)
- FR** Front speaker (R)
- C** Center speaker
- SW** Subwoofer
- SL** Surround speaker (L)
- SR** Surround speaker (R)

• Install the surround speakers in a position 60 to 90 cm higher than ear level.

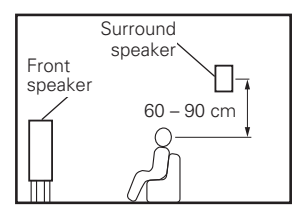

[Viewed from the side]

2 Connect



Speakers

Carefully check the left (L) and right (R) channels and + (red) and - (black) polarities on the speakers being connected to the this unit, and be sure to interconnect the channels and polarities correctly.

Connecting the speaker cables

Peel off about 10 mm of sheathing from the tip of the speaker cable, then either twist the core wire tightly or terminate it.

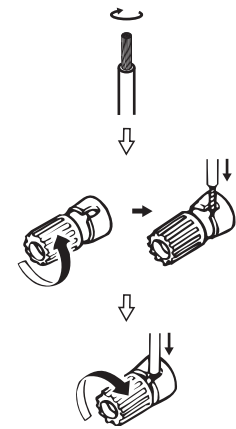

NOTE

- Connect so that the speaker cable core wires do not protrude from the speaker terminal. The protection circuit may be activated if the core wires touch the rear panel or if the + and - sides touch each other (see page 50 "Protection Circuit").
- Never touch the speaker terminals while the power supply is connected. Doing so could result in electric shock.
- Use speakers with the speaker impedances shown below.

Speaker terminals	Speaker impedance
FRONT	6 - 16 Ω
CENTER	
SURROUND	

The "Simple version" describes the installation, connection and setup methods for 5.1-channel speakers. See page 27 for the installation and connection for speakers other than 5.1-channel speakers.

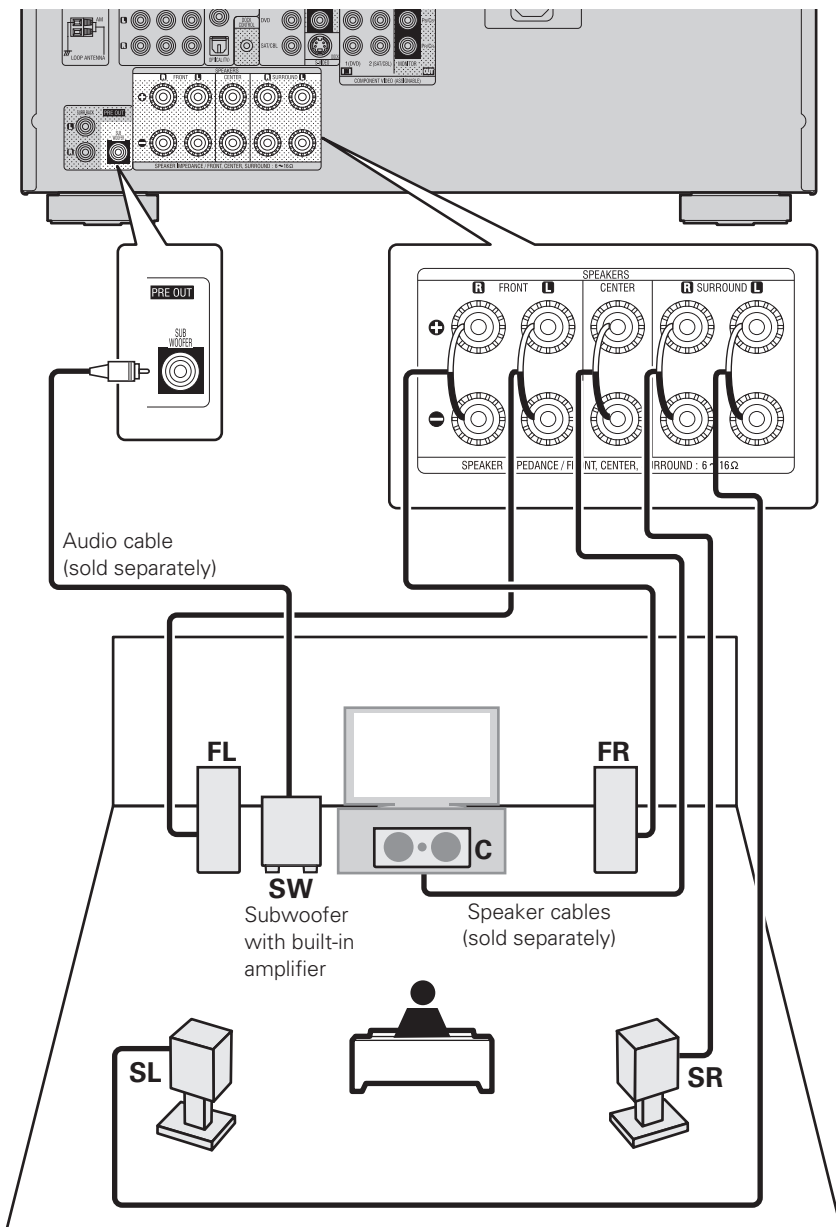

Blu-ray Disc player and TV

Use only an HDMI (High Definition Multimedia Interface) cable that bears the HDMI logo (a certified HDMI product). Using a cable without the HDMI logo (an uncertified HDMI product) may result in abnormal playback. When outputting Deep Color or 1080p, etc., we recommend you use "High Speed HDMI cable" or "High Speed HDMI cable with Ethernet" for enhanced high-quality playback.

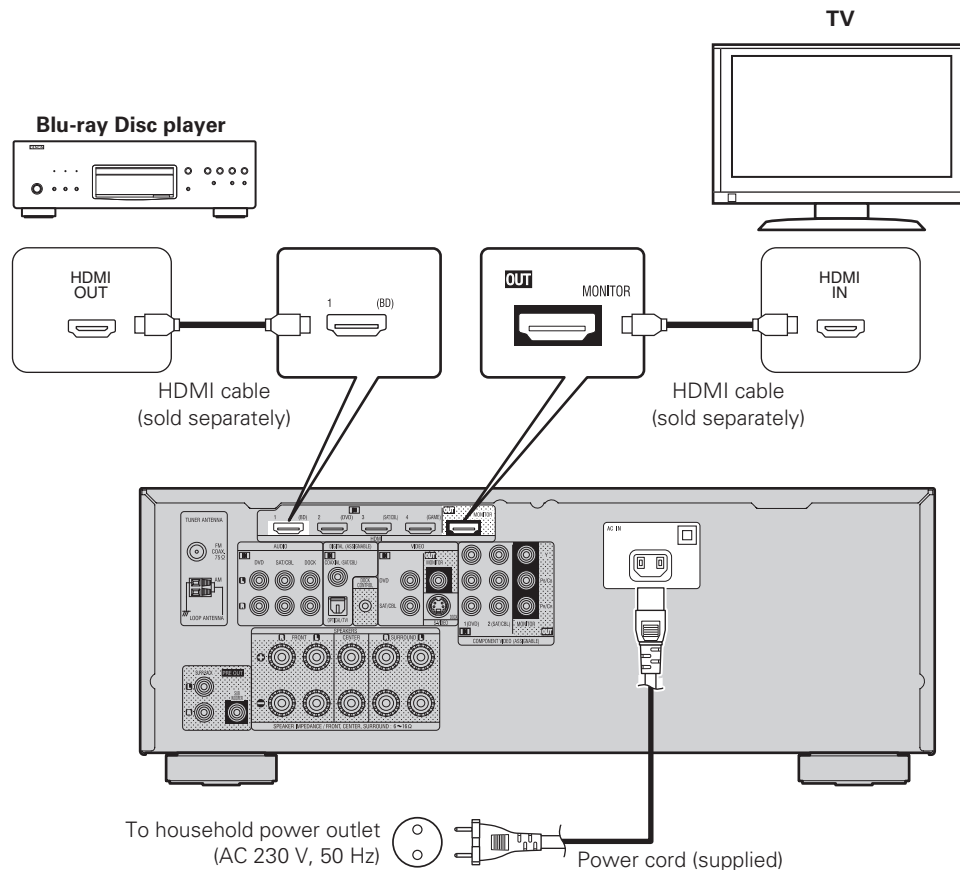

NOTE

- Do not plug in the power cord until all connections have been completed.
- Do not bundle power cords together with connection cables. Doing so can result in humming or noise.

The "Simple version" describes the installation, connection and setup methods for 5.1-channel speakers. See page 27 for the installation and connection for speakers other than 5.1-channel speakers.

3 Turn on power



1 Turn on the TV and subwoofer power.

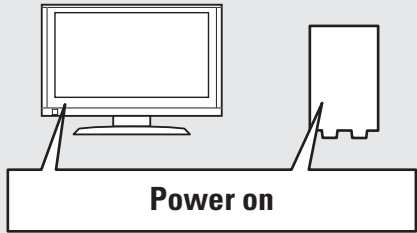

2 Change the TV input to the input of this unit.

3 Press **POWER ON** to turn on power to the unit.
The power indicator flashes green and the power turns on.

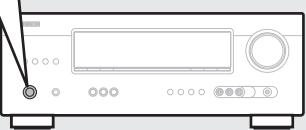
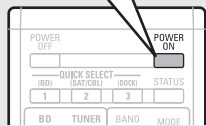

4 Set up speakers



The settings for the following 5 items should be made:

- Speaker Config.** Select speaker configuration and size (bass reproduction capability).
- Bass Setting** Set subwoofer and LFE signal range playback.
- Distance** Set distance from listening position to speakers. Measure beforehand the distance from the listening position to each speaker.
- Channel Level** Set the volume of the test tone to be the same when it is output from each speaker.
- Crossover Freq.** Set the maximum frequency of the bass signal output from each channel to the subwoofer. Set the Crossover Frequency to suit the bass reproduction capability of the speaker being used.

Menu operation

1 Press **MENU**.
The menu is displayed on the display of this unit.

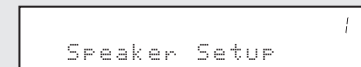

2 Press **ENTER**.

3 Use Δ / ∇ to select the menu to be set or operated, and then press **ENTER**.

4 Use \triangleleft / \triangleright to select a detailed setting, and then press **ENTER**.

- To return to the previous item, press **RETURN**.
- Exiting the Menu, press **MENU** while the menu is displayed. The menu returns to normal display.

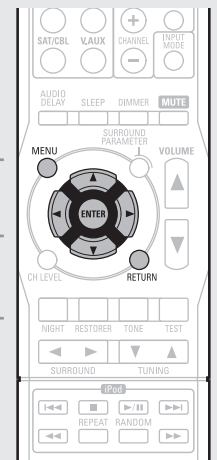

Speaker Config.

Default settings are underlined>.

1 Press MENU.

The menu is displayed on the display of this unit.



2 Use Δ / ∇ to select "Speaker Setup", and then press ENTER.



3 Use Δ / ∇ to select "Speaker Config.", and then press ENTER.



NOTE

Do not use the outward shape of the speaker to determine selection of a "Large" or "Small" speaker. Instead, use the frequencies set in "Crossover Frequency" (page 9) as the standard for determining bass reproduction capability.

4 Use Δ / ∇ to select a speaker, and use \triangleleft / \triangleright to select a detailed setting.

Items to be set are shown below.

Front Set the front speaker size.

- **Large** : Use a large speaker that can adequately play back low frequencies.
- **Small** : Use a small speaker that has inadequate playback capacity for low frequencies.



- When "SW" is set to "No", "Front" is automatically set to "Large".
- When "Front" is set to "Small", "Center", "Surround" and "S.B(Pre)" can not be set to "Large".

Center Set the presence and size of the center speaker.

- **Large** : Use a large speaker that can adequately play back low frequencies.
- **Small** : Use a small speaker that has inadequate playback capacity for low frequencies.
- **None** : Select when a center speaker is not connected.



- "Large" is not displayed when "Front" is set to "Small".

Surround Set the presence and size of the surround speakers.

- **Large** : Use a large speaker that can adequately play back low frequencies.
- **Small** : Use a small speaker that has inadequate playback capacity for low frequencies.
- **None** : Select when the surround speakers are not connected.



- When "Surround" is set to "Large", "S.B(Pre)" can be set to "Large".
- When "Surround" is set to "None", "S.B(Pre)" can automatically set to "None".

S.B(Pre) (Surround Back) Set the presence, size and number of surround back speakers.

- **Large** : Use a large speaker that can adequately play back low frequencies.
- **Small** : Use a small speaker that has inadequate playback capacity for low frequencies.
- **None** : Select when the surround back speakers are not connected.

- Even when the "S.B(Pre)" setting is other than "None", sound may not be emitted from the surround back speaker, depending on the playback source. In this case, make "Surround Parameter" – "SB CH OUT" (page 37) setting other than "OFF".

SW (Subwoofer) Set the presence of a subwoofer.

- **Yes** : Use a subwoofer.
- **No** : Select when a subwoofer is not connected.

- When "Front" is set to "Small", "SW" is automatically set to "Yes".

5 Press ENTER to enter the setting.

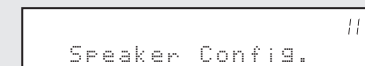

Remote control operation buttons



Move the cursor (Up/Down/Left/Right)



ENTER Confirm the setting



RETURN Return to previous menu

Bass Setting

Default settings are underlined.

- 1** Use \triangle / ∇ to select “Bass Setting”, and then press **ENTER**.

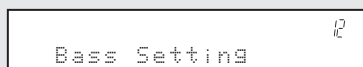



- 2** Use \triangleleft / \triangleright to select the frequency.

LFE Set LFE signal playback range.

- 80Hz / 90Hz / 100Hz / 110Hz / 120Hz / 150Hz / 200Hz / 250Hz

- 3** Use \triangle / ∇ to select “Mode”, and use \triangleleft / \triangleright to select a detailed setting.



Mode Select low range signals to be reproduced by subwoofer.

- **LFE** : The low range signal of the channel set to “Small” speaker size is added to the LFE signal output from the subwoofer.
- **LFE+Main** : The low range signal of all channels is added to the LFE signal output from the subwoofer.



- “Mode” can be set when “Speaker Config.” – “SW” (page 7) is set to “Yes”.
- Play music or a movie source and select the mode offering the strongest bass.
- Select “LFE+Main” if you want the bass signals to always be produced from the subwoofer.

NOTE

If “Front” and “Center” for “Speaker Config.” are set to “Large”, and “Mode” is set to “LFE”, no sound may be output from the subwoofers, depending on the input signal or selected surround mode.

- 4** Press **ENTER** to enter the setting.

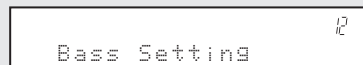

Distance

Default settings are underlined.

- 1** Use \triangle / ∇ to select “Distance”, and then press **ENTER**.

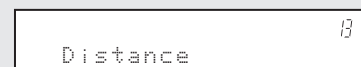

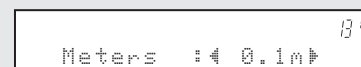

- 2** Use \triangleleft / \triangleright to change the step (minimum variable distance).

- 0.1m : For changing in 0.1-meter steps.
- 0.01m : For changing in 0.01-meter steps.

- 3** Use \triangle / ∇ to select a speaker, and use \triangleleft / \triangleright to select distance.

FL / FR / C / SW / SL / SR / SBL* / SBR*

Select the speaker.

* When the “Speaker Config.” – “S.B(Pre)” (page 7) setting is set to “None”, “SBL” and “SBR” is not displayed.

- **0.00m – 18.00m** : Set the distance.



- The speakers that can be selected differ depending on the “Speaker Config.” (page 7) settings.

• Default settings :

FL / FR / C / SW : 3.6 m
SL / SR / SBL / SBR : 3.0 m

- Set the difference in the distance between the speakers to less than 6.0 m.

NOTE

Speakers set to “None” in “Speaker Config.” (page 7) are not displayed.

- 4** Press **ENTER** to enter the setting.



Channel Level

Default settings are underlined>.

- 1** Use Δ / ∇ to select “Channel Level”, and then press **ENTER**.

Channel Level 14



Test Tone Start 14

- 2** Press **ENTER**.
Output test tone.

- 3** Use Δ / ∇ to select a speaker, and use \triangleleft / \triangleright to adjust the sound volume of each speaker to be equal.

FL / C / FR / SR / SBR* / SBL* / SL / SW

Select the speaker.

* When the “Speaker Config.” – “S.B(Pre)” (page 7) setting is set to “None”, “SBL” and “SBR” is not displayed.

- **-12.0dB – +12.0dB (0.0dB)** : Adjust the volume.



- When \triangleleft is pressed while the subwoofer volume is set to “-12 dB”, the “SW” setting switches to “OFF”.
- When “Channel Level” is adjusted, the adjusted values are set for all the surround modes. To adjust the channel level separately for the different surround modes, use the operation see page 29.

NOTE

- Speakers set to “None” in the “Speaker Config.” (page 7) settings are not displayed.
- When a headphones jack is inserted in the PHONES jack of this unit, the “Channel Level” is not displayed.

Default The “Channel Level” settings are returned to the default settings.

- **Yes** : Reset to the defaults.
- **No** : Do not reset to the defaults.

- 4** Press **ENTER** to enter the setting.

Test Tone Start 14

- 5** Press **RETURN**.

Channel Level 14

Outputting a test tone directly with remote control operation

This is operable when the surround mode is Dolby Pro Logic II, Dolby Pro Logic IIx, or DTS NEO:6.

- ① Press **TEST**.
The test tone is output from the “L” channel of the front speakers.
- ② Use \triangleleft / \triangleright to adjust the sound volume of each speaker to be equal.
- ③ Use Δ / ∇ to select the next speaker for outputting the test tone.
- ④ Once adjustment is completed, press **TEST** again.

Crossover Freq.

Default settings are underlined>.

- 1** Use Δ / ∇ to select “Crossover Freq.”, and then press **ENTER**.

Crossover Freq. 15



Front : 1 80Hz 15

- 2** Use Δ / ∇ to select a speaker, and use \triangleleft / \triangleright to select the frequency.

Front / Center / Surround / S.Back

Specify crossover frequency for each speaker.

- **40Hz / 60Hz / 80Hz / 90Hz / 100Hz / 110Hz / 120Hz / 150Hz / 200Hz / 250Hz** : Set the crossover frequency.



- “Crossover Freq.” can be set when the “Bass Setting” – “Mode” (page 8) setting is “LFE+Main”, or when you have a speaker that is set to “Small”.
- Always set the crossover frequency to “80Hz”. When using small speakers, however, we recommend setting the crossover frequency to a higher frequency.
- For speakers set to “Small”, sound below the crossover frequency is cut from the sound output. The cut bass sound is output from the subwoofer or front speakers.
- The “Mode” setting (page 8) determines which speakers can be set.
- When “LFE” is selected, speakers set to “Small” at “Speaker Config.” can be set. If the speakers are set to “Large”, “- Full -” is displayed and the setting cannot be made.
- If set to “LFE+Main”, this setting can be made regardless of the speaker size.

- 3** Press **ENTER** to enter the setting.

Crossover Freq. 15

- 4** Press **MENU**.

The menu returns to normal display.

Remote control operation buttons



Move the cursor
(Up/Down/Left/Right)



ENTER Confirm the setting



RETURN Return to previous menu

5 Play back disc



1 Press **BD** to switch an input source for a player used for playback.

2 Play the component connected to this unit.

Make the necessary settings on the player (language setting, subtitles setting, etc.) beforehand.

3 Adjust the sound volume.

VOL ▲ Volume up
VOL ▼ Volume down
MUTE Muting

4 Set the listening mode.

Set the listening mode according to the playback contents (cinema, music, etc.) or according to your liking (see page 23 "Selecting a listening mode (Surround mode)").



When power is switched to standby

Press **POWER OFF**.

[Power indicator status in standby mode]

- Normal standby : Off

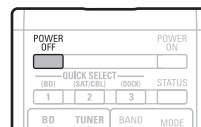

You can also switch the power to standby by pressing **ON/STANDBY** on the main unit.

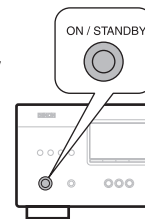



NOTE















During power standby, a minimal amount of power is consumed. To totally cut off the power, remove the power cord from the power outlet.

Basic version

Here, we explain the connections and basic operation methods for this unit.

- **Connections**  page 12
- **Playback (Basic operation)**  page 17
- **Selecting a listening mode (Surround mode)**  page 23

Refer to the pages indicated below for information on connecting and playing back the various media and external devices.

Audio and video	Connection	Playback
TV	 page 12, 13	–
Blu-ray Disc player	 page 12, 14	 page 17
DVD player	 page 12, 14	 page 17
Set-top box (Satellite tuner or cable TV)	 page 12, 14	–
Game console	 page 12	–
Digital camcorder	 page 15	–
Control dock for iPod	 page 16	 page 18
Portable player	 page 15	 page 17
Audio	Connection	Playback
Radio	 page 16	 page 20

For speaker connections, see page 4.

Connections

Important information

- Make connections as follows before using this unit. Select an appropriate connection type according to the components to be connected.
- You may need to make some settings on this unit depending on the connection method. Refer to each description for more information.
- Select the cables (sold separately) according to the components being connected.

NOTE

- Do not plug in the power cord until all connections have been completed.
- When making connections, also refer to the operating instructions of the other components being connected.
- Be sure to connect the left and right channels properly (left with left, right with right).
- Do not bundle power cords together with connection cables. Doing so can result in noise.

Connecting an HDMI-compatible device

You can connect up to five HDMI-compatible devices to the unit.

HDMI function

- 3D
- Deep Color (page 50)
- x.v.Color, sYCC601 color, Adobe RGB color, Adobe YCC601color (page 50, 51)
- High definition digital audio format

Copyright protection system

In order to play back digital video and audio such as BD-Video or DVD-Video via HDMI connection, both this unit and TV or the player need to support the copyright protection system known as HDCP (High-bandwidth Digital Content Protection System). HDCP is copyright protection technology comprised of data encryption and authentication of the connected AV device. This unit supports HDCP.

- If a device that does not support HDCP is connected, video and audio are not output correctly. Read the owner's manual of your television or player for more information.

About HDMI cables

When a device supporting Deep Color signal transfer is connected, use a cable compatible "High Speed HDMI cable" or "High Speed HDMI cable with Ethernet".

About 3D function

This unit supports input and output of 3D (3 dimensional) video signals of the HDMI 1.4a standards. For playing the 3D video content, a player, and a TV that support the 3D function of the HDMI 1.4a standards are required in addition to this unit.

Cables used for connections

Audio and video cable (sold separately)

HDMI cable



- This interface allows transfer of digital video signals and digital audio signals over a single HDMI cable.

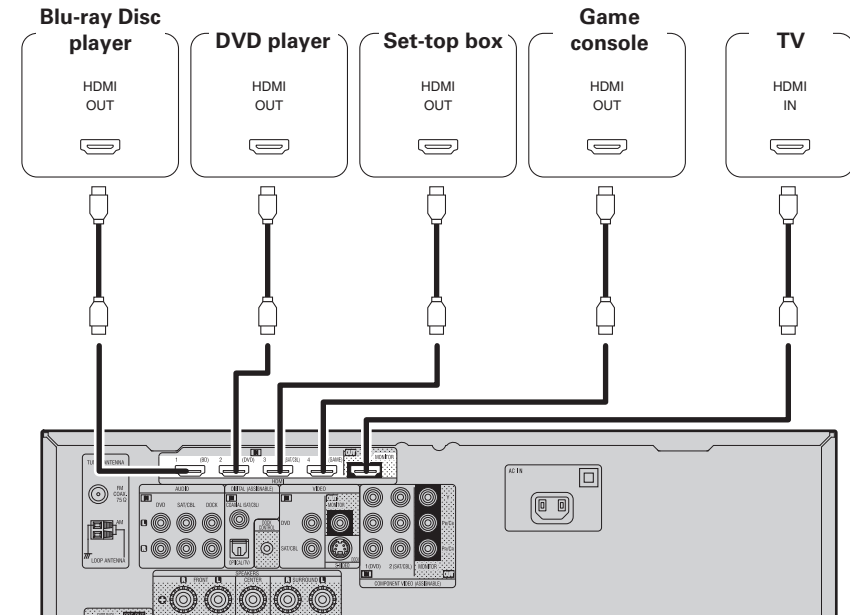

- When this unit is connected to other devices with HDMI cables, connect this unit and TV also with an HDMI cable.
- When connecting a device that supports Deep Color transmission, please use a "High Speed HDMI cable" or "High Speed cable with Ethernet".
- Video signals are not output if the input video signals do not match the monitor's resolution. In this case, switch the Blu-ray Disc/DVD player's resolution to a resolution with which the monitor is compatible.
- When this unit and monitor are connected with an HDMI cable, if the monitor is not compatible with HDMI audio signal playback, only the video signals are output to the monitor.

NOTE

- The audio signal from the HDMI output connector (sampling frequency, number of channels, etc.) may be limited by the HDMI audio specifications of the connected device regarding permissible inputs.
- Only an HDMI signal is output from the HDMI MONITOR OUT connector.

Connecting an HDMI-compatible device

Connecting to a device equipped with a DVI-D connector

When an HDMI/DVI conversion cable (sold separately) is used, the HDMI video signals are converted to DVI signals, allowing connection to a device equipped with a DVI-D connector.

NOTE

- No sound is output when connected to a device equipped with a DVI-D connector. Make separate audio connections.
- Signals cannot be output to DVI-D devices that do not support HDCP.
- Depending on the combination of devices, the video signals may not be output.

Settings related to HDMI connections

Set as necessary. For details, see the respective reference pages.

Other Setup (page 36)

Make settings for HDMI audio output.

- Audio Out

NOTE

The audio signals output from the HDMI connectors are only the HDMI input signals.

Connecting a TV

- Select the connector to use and connect the device.
- For instructions on HDMI connections, see "Connecting an HDMI-compatible device" (page 12).



To listen to TV audio through this device, use the optical digital connection.

NOTE

- If the VIDEO input connector and S-VIDEO input connector are to be used, be sure to connect the MONITOR output connector of the unit and the VIDEO input connector of the TV, using a video cable.
- If the COMPONENT VIDEO input connectors are to be used, be sure to connect the COMPONENT MONITOR output connectors of the unit and the COMPONENT VIDEO input connectors of the TV, using a component video cable.

Cables used for connections

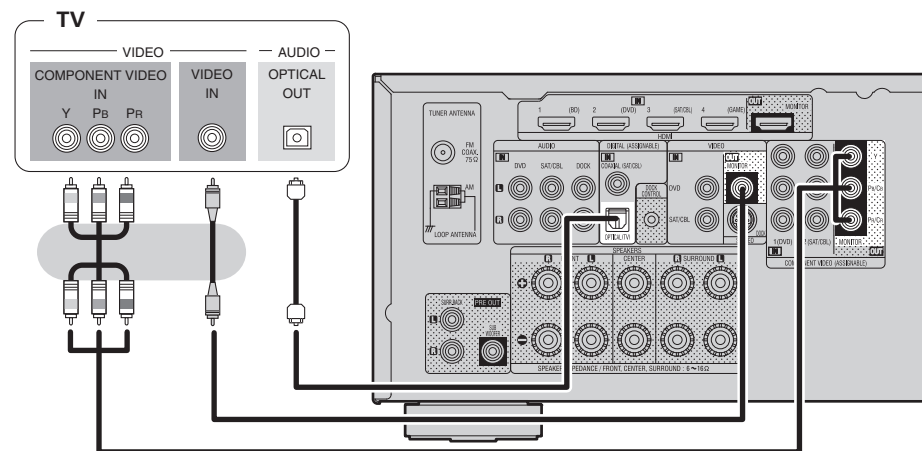
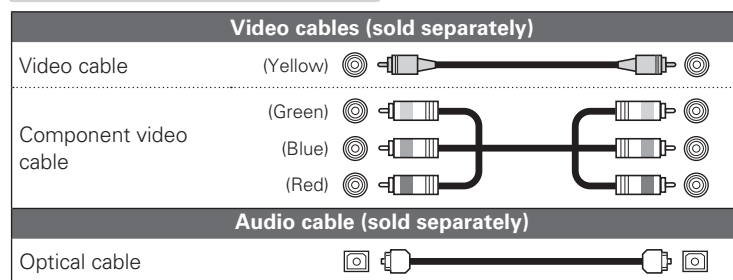

in Set as Necessary

Set this to change the digital input connector or component video input connector to which the input source is assigned.

"Input Assign" (page 33)

Connecting a Blu-ray Disc player / DVD player

- You can enjoy video and audio from a Blu-ray Disc or DVD.
- Select the connector to use and connect the device.
- For instructions on HDMI connections, see “Connecting an HDMI-compatible device” (page 12).

NOTE

- If the DVD VIDEO input connector is to be used, be sure to connect the MONITOR output connector of the unit and the VIDEO input connector of the TV, using a video cable.
- If the DVD COMPONENT VIDEO input connectors are to be used, be sure to connect the COMPONENT MONITOR output connectors of the unit and the COMPONENT VIDEO input connectors of the TV, using a component video cable.

Cables used for connections

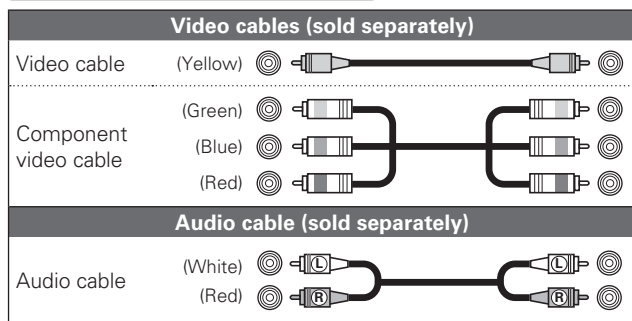

Blu-ray Disc player / DVD player

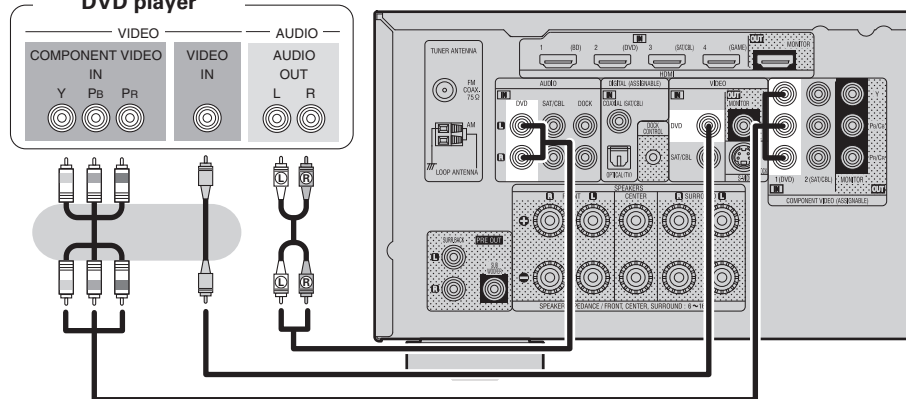

in Set as Necessary

Set this to change the digital input connector or component video input connector to which the input source is assigned.

“Input Assign” (page 33)



For HD audio (Dolby TrueHD, DTS-HD, Dolby Digital Plus and DTS Express) playback, connect with HDMI (page 12 “Connecting an HDMI-compatible device”).

Connecting a set-top box (Satellite tuner/cable TV)

- You can watch satellite or cable TV.
- Select the connector to use and connect the device.
- For instructions on HDMI connections, see “Connecting an HDMI-compatible device” (page 12).

NOTE

- If the SAT/CBL VIDEO input connector is to be used, be sure to connect the MONITOR output connector of the unit and the VIDEO input connector of the TV, using a video cable.
- If the SAT/CBL COMPONENT VIDEO input connectors are to be used, be sure to connect the COMPONENT MONITOR output connectors of the unit and the COMPONENT VIDEO input connectors of the TV, using a video cable.

Cables used for connections

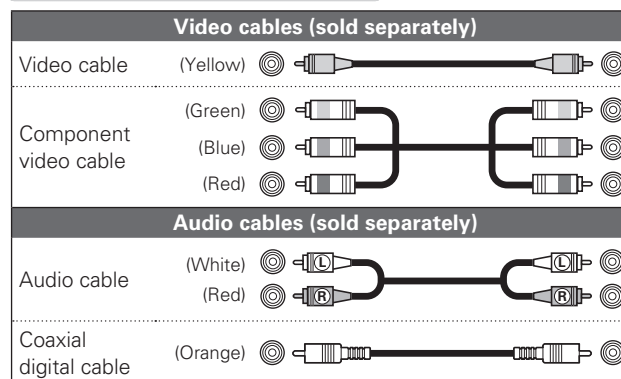

Satellite Tuner/Cable TV

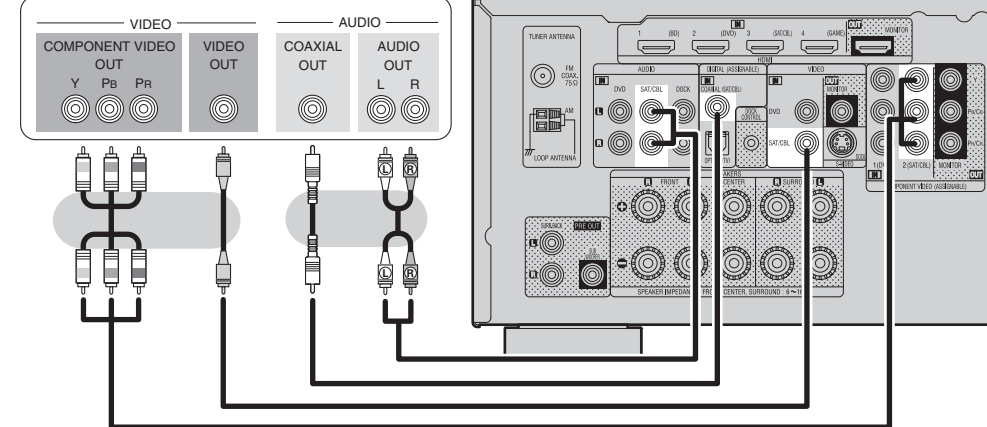

in Set as Necessary

Set this to change the digital input connector or component video input connector to which the input source is assigned.

“Input Assign” (page 33)

Connecting a digital camcorder

- You can enjoy video and audio from a digital camcorder.
- For instructions on HDMI connections, see “Connecting an HDMI-compatible device” (page 12).

Cables used for connections

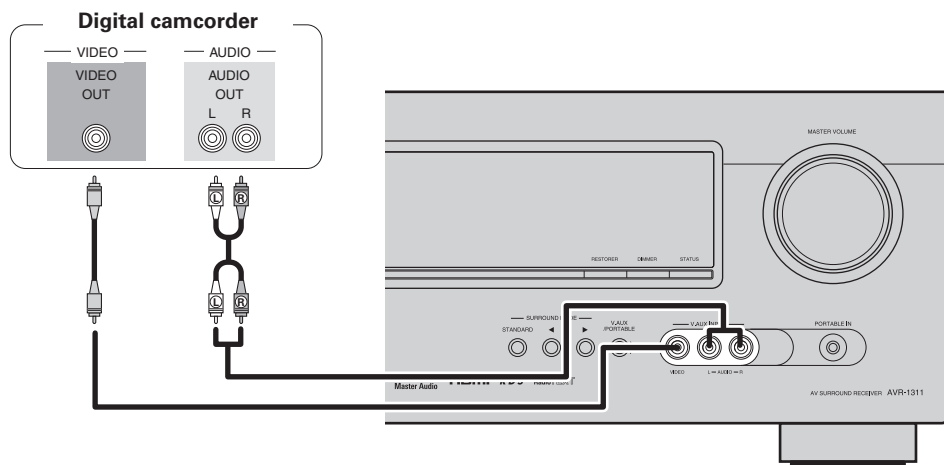
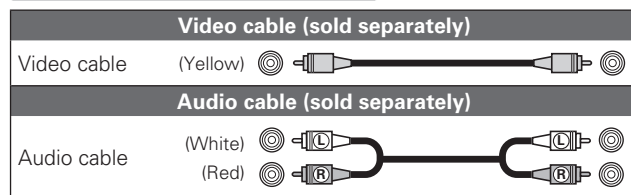

in Set as Necessary

Set this to change the digital input connector or component video input connector to which the input source is assigned.

“Input Assign” (page 33)



- You can enjoy games by connecting a game machine via the V.AUX input connector. In this case, set the input source to “V.AUX”.
- If a portable player is connected via the PORTABLE IN jack on the front panel, playback from the portable player has priority.

Connecting a portable player

If a portable player is connected via the PORTABLE IN jack of the unit, music from the portable player can be played.

Cables used for connections

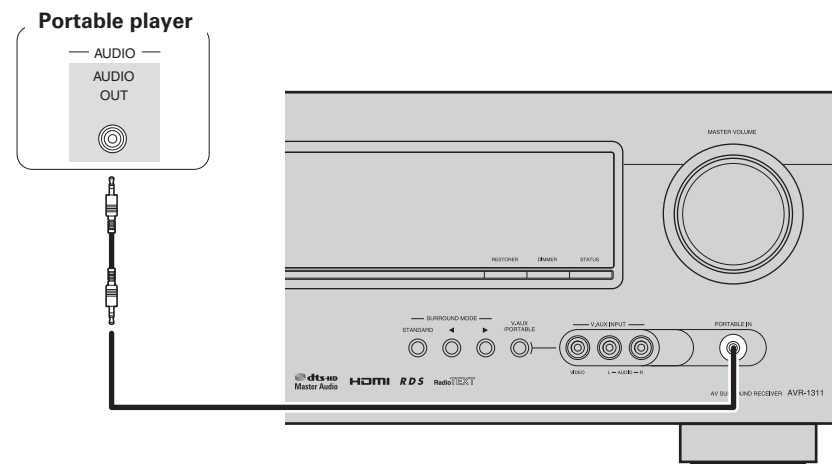
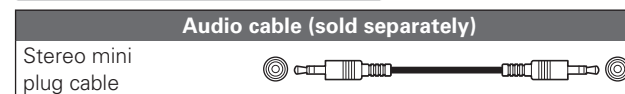

Connecting a control dock for iPod

- Connect a control dock for iPod to the unit to enjoy video and music stored on an iPod.
- For a control dock for iPod, use ASD-11R, ASD-3N, ASD-3W, ASD-51N and ASD-51W made by DENON (sold separately).
- For instructions on the control dock for iPod settings, refer to the control dock for iPod's operating instructions.

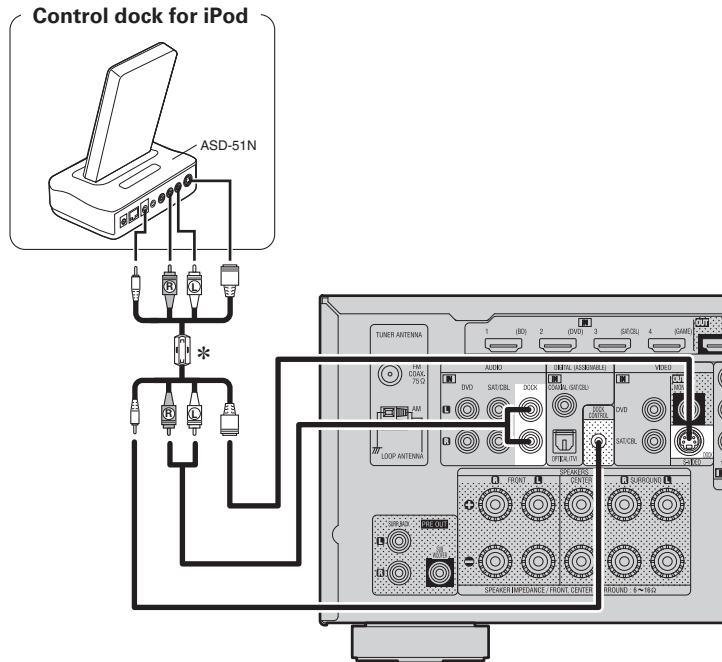

* Use the AV/Control Cable supplied with the DENON control dock for iPod.

in Set as Necessary

Set this to change the digital input connector to which the input source is assigned.

"Input Assign" (page 33)

Connecting an antenna

- Connect the FM antenna or AM loop antenna supplied with the unit to enjoy listening to radio broadcasts.
- After connecting the antenna and receiving a broadcast signal (page 20 "Listening to FM/AM broadcasts"), fix the antenna with tape in a position where the noise level becomes minimal.

Direction of broadcasting station

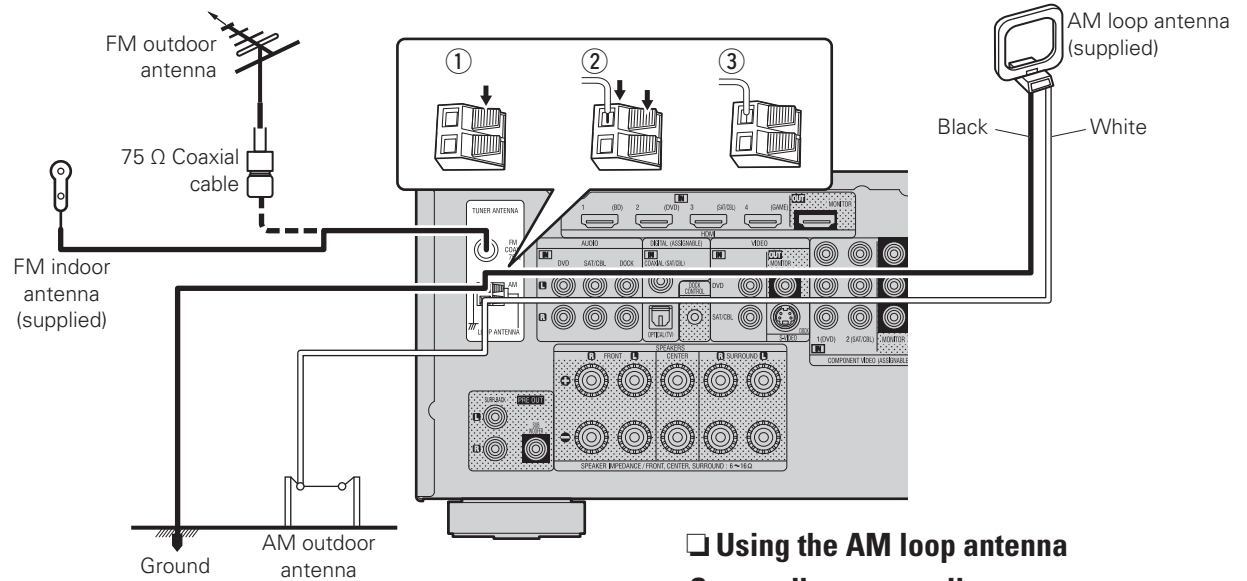

AM loop antenna assembly

1 Put the stand section through the bottom of the loop antenna from the rear and bend it forward.

2 Insert the projecting part into the square hole in the stand.

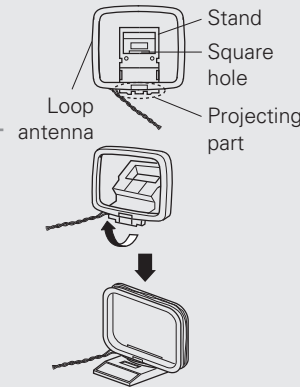

Using the AM loop antenna Suspending on a wall

Suspend directly on a wall without assembling.

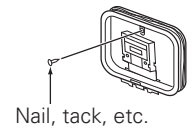

Standing alone

Use the procedure shown left to assemble.

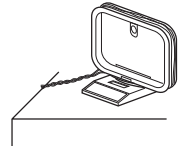

NOTE

- Do not connect two FM antennas simultaneously.
- Even if an external AM antenna is used, do not disconnect the AM loop antenna.
- Make sure the AM loop antenna lead terminals do not touch metal parts of the panel.
- If the signal has noise interference, connect the ground terminal (GND) to reduce noise.
- If you are unable to receive a good broadcast signal, we recommend installing an outdoor antenna. For details, inquire at the retail store where you purchased the unit.

Playback (Basic operation)

- ❑ **Selecting the input source** (☞ page 17)
- ❑ **Adjusting the master volume** (☞ page 17)
- ❑ **Turning off the sound temporarily** (☞ page 17)

- ❑ **Playing a Blu-ray Disc player/DVD player** (☞ page 17)
- ❑ **Playing a portable player** (☞ page 17)
- ❑ **Playing an iPod®** (☞ page 18)
- ❑ **Tuning in radio stations** (☞ page 20)

Selecting a listening mode (Surround mode)
(☞ page 23)

Playback (Advanced operation) (☞ page 29)

Important information

Before starting playback, make the connections between the different components and the settings on the receiver.

NOTE

Also refer to the operating instructions of the connected components when playing them.

Selecting the input source

Press the input source select button (DVD, BD, TUNER, DOCK, SAT/CBL, GAME, V.AUX*, TV) to be played back.

The desired input source can be selected directly.

* For operation with the main unit, use **V.AUX/PORTABLE**.

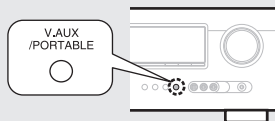
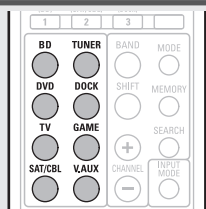

Adjusting the master volume

Use **VOL ▲▼** to adjust the volume.

- ❑ When the "Volume Display" setting (☞ page 35) is "Relative" [Adjustable range] --- -80.5dB - 18.0dB

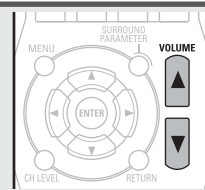

- ❑ When the "Volume Display" setting (☞ page 35) is "Absolute" [Adjustable range] 0.0 - 99.0

• The variable range differs according to the input signal and channel level setting.



You can also operate via the main unit. In this case, perform the following operations. Turn **MASTER VOLUME** to adjust the volume.

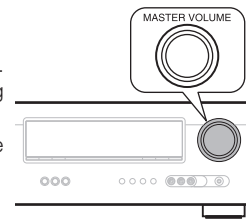

Turning off the sound temporarily

Press **MUTE**.

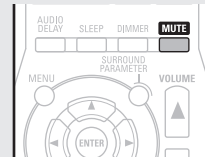

- The sound is reduced to the level set at "Mute Level" (☞ page 35).
- To cancel, press **MUTE** again. Muting can also be canceled by adjusting the master volume.

Playing a Blu-ray Disc player/DVD player

The following describes the procedure for playing Blu-ray Disc player/DVD player.

- 1 Prepare for playback.**
 - ① Turn on the power of the TV, subwoofer and player.
 - ② Change the TV input to the input of this unit.
 - ③ Load the disc in the player.
- 2 Press POWER ON to turn on power to the unit.**
- 3 Press BD or DVD to switch an input source for a player used for playback.**
- 4 Play the component connected to this unit.** Make the necessary settings on the player (language setting, subtitles setting, etc.) beforehand.



Playing a portable player

The following describes the procedure for playing portable player.

- 1 Connect the portable player to this unit** (☞ page 15 "Connecting a portable player").
- 2 Press POWER ON to turn on power to the unit.**
- 3 Press V.AUX to switch the input source to "V.AUX".**
- 4 Play the component connected to this unit.**

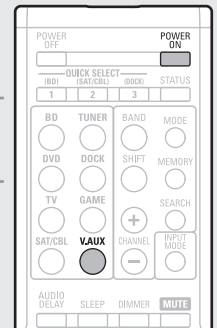

Playing an iPod®

You can play back both video, photo and audio.

Listening to music on an iPod®

DENON Control dock for iPod usable on this unit
 • ASD-11R/ASD-3N/ASD-3W/ASD-51N/ASD-51W

1 Prepare for playback.

- ① Connect the DENON control dock for iPod to this unit (page 16 “Connecting a control dock for iPod”).
- ② Set the iPod® in the DENON control dock for iPod.

2 Press POWER ON to turn on power to the unit.

3 Press DOCK to switch the input source to “DOCK”.

- If “Browse mode” is selected in step 4, the following screen is displayed on a TV screen.
 When ASD-11R is used, iPod information is not displayed on a TV screen. It is displayed on the display of the unit.

[When using an ASD-3N, ASD-3W, ASD-51N and ASD-51W]

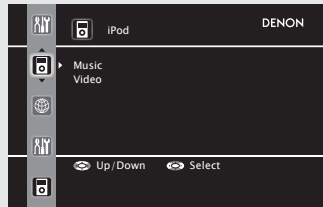

- In “Browse mode”, the iPod display is as shown at right.



NOTE

- If the connections screen is not displayed, the iPod may not be properly connected. Reconnect it.
- For operating an iPod while viewing on a TV screen, connect the VIDEO MONITOR output connectors on this unit and the VIDEO input connectors on the TV, using a video cable.

4 Press SEARCH and hold it down for 2 seconds or more to select the display mode.

- There are two modes for displaying the contents recorded on the iPod.

Browse mode Display iPod information on the TV screen or display of this unit.

- English letters, numbers and certain symbols are displayed. Incompatible characters are displayed as “.” (period).

Remote mode Display iPod information on the iPod screen.

- “Dock Remote” is displayed on the display of this unit.

	Display mode	Browse mode	Remote mode
Playable files	Music file	✓	✓
	Photo file		✓ *
	Video file	✓	✓ *
Active buttons	Remote control unit (This unit)	✓	✓
	iPod®		✓

- * Video may not be output, depending on the combination of ASD-11R, ASD-3N, ASD-3W, ASD-51N or ASD-51W DENON control dock for iPod and iPod.

5 Use Δ∇ to select the item, then press ENTER or ▷ to select the file to be played.

6 Press ENTER or ▷. Playback starts.

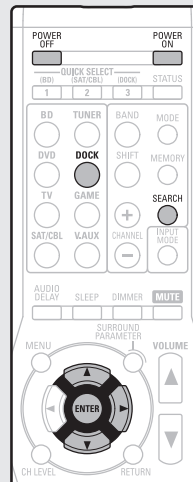

- To play back compressed audio with extended bass or treble reproduction, we recommend playback in RESTORER mode (page 38). The default setting is “ON”.
- In Browse mode, press **STATUS** during playback to check the title name, artist name, and album name.

NOTE

- Press **POWER OFF** and set this unit’s power to the standby mode before disconnecting the iPod. Also switch the input source to “DOCK” before disconnecting the iPod.
- Depending on the type of iPod and the software version, some functions may not operate.
- Note that DENON will accept no responsibility whatsoever for any problems arising with the data on an iPod when using this unit in conjunction with the iPod.

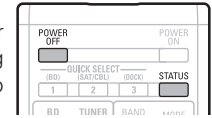

Viewing videos on an iPod® in the Browse mode

When an iPod equipped with a video function is connected to a DENON ASD-11R, ASD-3N, ASD-3W, ASD-51N and ASD-51W control dock for iPod, image files can be played in the Browse mode.

1 Use Δ∇ to select “Videos”, then press ENTER or ▷.

2 Use Δ∇ to select the search item or folder, then press ENTER or ▷.

3 Use Δ∇ to select the video file, then press ENTER or ▷. Playback starts.

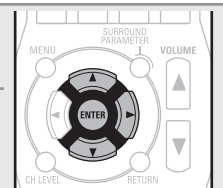

Viewing photos and videos on an iPod® in the Remote mode

This unit can play back on a TV screen photos and data stored on an iPod equipped with a slide show or video function.

1 Press and hold **SEARCH** to set the Remote mode.

"Dock Remote" is displayed on the display of this unit.



2 Watching the iPod's screen, use Δ / ∇ to select "Photos" or "Videos".

• Depending on the iPod model, it may be necessary to operate the iPod unit directly.

3 Press **ENTER** until the image you want to view is displayed.



"TV Out" at the iPod's "Slide show Settings" or "Video Settings" must be set to "On" in order to display the iPod's photo data or videos on the monitor. For details, see the iPod's operating instructions.

NOTE

Video may not be output, depending on the combination of ASD-11R, ASD-3N, ASD-3W, ASD-51N or ASD-51W and iPod.

iPod operation

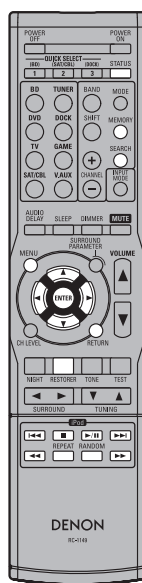

Operation buttons	Function
MENU	Amp menu
Δ / ∇ / \triangleleft / \triangleright	Cursor operation
ENTER	Enter
SEARCH (Press and hold)	Browse / Remote mode switching
RETURN	Return
$\triangleleft\triangleleft$ / $\triangleright\triangleright$ (Press and hold)	Manual search (fast-reverse/fast-forward)
\triangleright / II	Playback / Pause
$\triangleleft\triangleleft$ / $\triangleright\triangleright$ / I	Auto search (cue)
■	Stop
REPEAT	Repeat playback
RANDOM	Shuffling playback
RESTORER	RESTORER
MEMORY	Store memory *
STATUS	Check of title name/artist name/album name (in Browse mode)

• **Repeat playback** (☞ page 35 "Repeat")

• **Shuffling playback** (☞ page 35 "Shuffle")

* This functions when an ASD-3N, ASD-3W, ASD-51N or ASD-51W is used.

Tuning in radio stations

Listening to FM/AM broadcasts

1 Press **TUNER** to switch the input source to “TUNER”.

2 Press **BAND** to select “FM” or “AM”.

FM When listening to an FM broadcast.

AM When listening to an AM broadcast.

3 Tune in the desired broadcast station.

1 To tune in automatically (Auto tuning)

Press **MODE** to light the “AUTO” indicator on the display, then use **TUNING ▲** or **TUNING ▼** to select the station you want to hear.

2 To tune in manually (Manual tuning)

Press **MODE** to turn off the display’s “AUTO” indicator, then use **TUNING ▲** or **TUNING ▼** to select the station you want to hear.

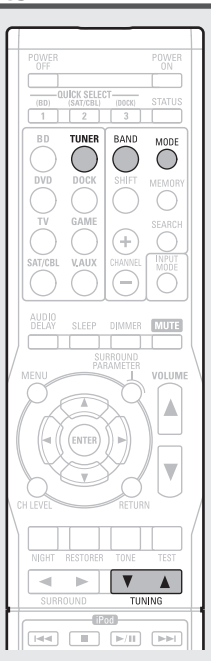

❑ Presetting radio stations (Manual preset)

Your favorite broadcast stations can be preset so that you can tune them in easily. Up to 56 stations can be preset.

• Stations can be preset automatically at “Auto Preset” (see page 34). If “Auto Preset” is performed after performing “Manual Preset”, the “Manual Preset” settings will be overwritten.

1 Tune in the broadcast station you want to preset.

2 Press **MEMORY**.

3 Press **SHIFT** to select the block (A to G) in which the channel (1 to 8 per a block) is to be preset, then press **CHANNEL +** or **CHANNEL -** to select the preset number.

4 Press **MEMORY** again to complete the setting.

• To preset other stations, repeat steps 1 to 4.

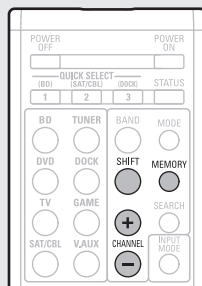

Default settings

Block (A – G) and Channel (1 – 8)	Default Settings
A1 – A8	87.5 / 89.1 / 98.1 / 108.0 / 90.1 / 90.1 / 90.1 / 90.1 MHz
B1 – B8	522 / 603 / 999 / 1404 / 1611 kHz, 90.1 / 90.1 / 90.1 MHz
C1 – C8	90.1 MHz
D1 – D8	90.1 MHz
E1 – E8	90.1 MHz
F1 – F8	90.1 MHz
G1 – G8	90.1 MHz

❑ Listening to preset stations

1 Press **SHIFT** to select the memory block (A to G).

2 Press **CHANNEL +** or **CHANNEL -** to select the desired preset channel.

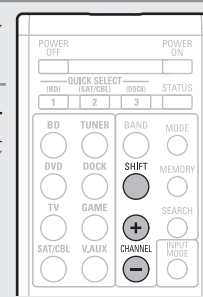

❑ Tuner (FM/AM) operation

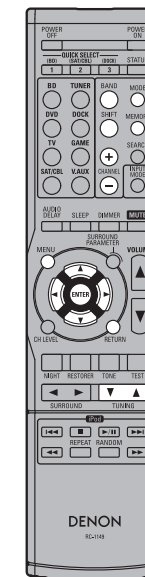

Operation buttons	Function
CHANNEL +, -	Preset channel selection
MENU	Amp menu
△▽◀▶	Cursor operation
ENTER	Enter
RETURN	Return
BAND	FM/AM switching
MODE	Switch search modes
TUNING ▲▼	Tuning (up/down)
SHIFT	Preset channel block selection
MEMORY	Preset memory registration



- If the desired station cannot be tuned in with auto tuning, tune it in manually.
- When tuning in stations manually, press and hold **TUNING ▲** or **TUNING ▼** to change frequencies continuously.

RDS (Radio Data System)

RDS (works only on the FM band) is a broadcasting service which allows a station to send additional information along with the regular radio program signal.

NOTE

The operations described as follows using **SEARCH** will not function in areas in which there are no RDS broadcasts.

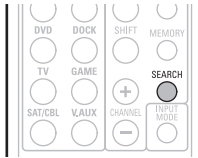

□ RDS search

Use this function to automatically tune to FM stations that provide the RDS service.

- 1** Press **TUNER** to switch the input source to “TUNER”.
- 2** Press **SEARCH** to select “RDS SEARCH”.
- 3** Press **CHANNEL +** or **CHANNEL -**.
The search for RDS stations begins automatically.

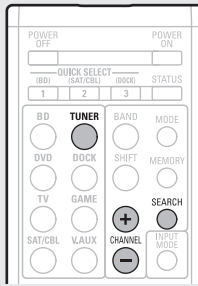

- If no RDS stations are found with the above operation, all the reception bands are searched.
- When a broadcast station is found, that station’s name appears on the display.
- If no RDS station is found when all the frequencies have been searched, “NO RDS” is displayed.



If you press **CHANNEL +** or **CHANNEL -** within 5 seconds after the broadcast station name is shown on the display, you can search for a different station.

PTY (Program Type)

PTY identifies the type of RDS program. The program types and their displays are as follows:

NEWS	News	WEATHER	Weather
AFFAIRS	Current Affairs	FINANCE	Finance
INFO	Information	CHILDREN	Children’s program
SPORT	Sports	SOCIAL	Social Affairs
EDUCATE	Education	RELIGION	Religion
DRAMA	Drama	PHONE IN	Phone In
CULTURE	Culture	TRAVEL	Travel
SCIENCE	Science	LEISURE	Leisure
VARIED	Varied	JAZZ	Jazz Music
POP M	Pop Music	COUNTRY	Country Music
ROCK M	Rock Music	NATION M	National Music
EASY M	Easy Listening Music	OLDIES	Oldies Music
LIGHT M	Light Classical	FOLK M	Folk Music
CLASSICS	Serious Classical	DOCUMENT	Documentary
OTHER M	Other Music		

□ PTY search

Use this function to find RDS stations broadcasting a designated program type (PTY).

- 1** Press **TUNER** to switch the input source to “TUNER”.
- 2** Press **SEARCH** to select “PTY SEARCH”.
- 3** Watching the display, press **Δ**/**∇** to call out the desired program type.
- 4** Press **CHANNEL +** or **CHANNEL -**.
PTY search begins automatically.



- If there is no station broadcasting the designated program type with the above operation, all the reception bands are searched.
- The station name is displayed on the display after searching stops.
- If no station broadcasting the designated program type is found when all the frequencies have been searched, “NO PROGRAMME” is displayed.



If you press **CHANNEL +** or **CHANNEL -** within 5 seconds after the broadcast station name is shown on the display, you can search for a different station.

TP (Traffic Program)

TP identifies programs that carry traffic announcements. This allows you to easily find out the latest traffic conditions in your area before leaving home.

TP search

Use this function to find RDS stations broadcasting traffic programs (TP stations).

1 Press **TUNER** to switch the input source to “TUNER”.

2 Press **SEARCH** to select “TP SEARCH”.

3 Press **CHANNEL +** or **CHANNEL -**.

TP search begins automatically.

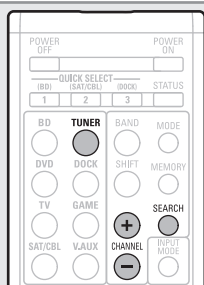

- If no TP station is found with the above operation, all the reception bands are searched.
- The station name is displayed on the display after searching stops.
- If no other TP station is found when all the frequencies have been searched, “NO PROGRAMME” is displayed.



If you press **CHANNEL +** or **CHANNEL -** within 5 seconds after the broadcast station name is shown on the display, you can search for a different station.

RT (Radio Text)

RT allows RDS stations to send text messages that appear on the display.

“RT” appears on the display when radio text data is received.

1 Press **TUNER** to switch the input source to “TUNER”.

2 Press **SEARCH** to select “RT”.

- While receiving an RDS broadcast station, the text data broadcast from the station is displayed.
- To turn the display off, press $\triangleleft \triangleright$.
- If no text data is being broadcast, “NO TEXT DATA” is displayed.



Selecting a listening mode (Surround mode)

This unit can play input audio signals in multi-channel surround mode or in stereo mode. Select a listening mode suitable for the playback contents (cinema, music, etc.) or according to your liking.

Listening Mode

Input audio signal	Playback	Listening mode	
2-channel Multi channel	Surround	Standard playback (☞ page 23)	For 2-channel signal input: <ul style="list-style-type: none"> Surround-channel signals are created and played with surround playback. For multichannel signal input: <ul style="list-style-type: none"> The surround signal recorded in source is played as surround playback. (The sound is played according to the settings of the speaker size in "Speaker Config." (☞ page 7).) Surround-back-channel signals that are not recorded in source can be created.
2-channel Multi channel	Surround	Multi channel stereo playback (☞ page 25)	This mode is for enjoying stereo sound from all speakers.
2-channel Multi channel	Surround	Virtual playback (☞ page 25)	This mode is for enjoying surround effects using only the front speakers or headphones.
2-channel Multi channel	Stereo	Stereo playback (☞ page 25)	<ul style="list-style-type: none"> If multichannel signals are input, they are mixed down to 2-channel audio and are played. Subwoofer signals are also output.
2-channel Multi channel	Stereo Surround	Direct playback (☞ page 25)	Sound recorded in source is played as is. <ul style="list-style-type: none"> Surround back signals are not created. In this mode, the following items cannot be adjusted. <ul style="list-style-type: none"> Tone (☞ page 38) RESTORER (☞ page 38)



- Some listening modes cannot be selected, depending on the audio format or number of channels of the input signal. For details, see "Types of input signals, and corresponding surround modes" (☞ page 48).
- Adjust the sound field effect with the menu "Surround Parameter" (☞ page 36) to enjoy your favorite sound mode.
- Buttons on the remote control unit or main unit can be used for operations.

[Operations with the remote control unit]

Press **SURROUND ◀** or **SURROUND ▶** and the modes are switched as shown below.

[Operations with the main unit]

Press **SURROUND MODE ◀** or **SURROUND MODE ▶** and the modes are switched as shown below.



* The display varies depending on the audio format or the number of channels of input signals.

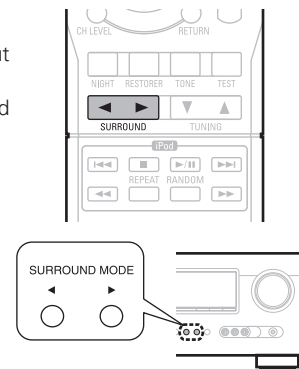

Standard playback

▣ Surround playback of 2-channel sources

1 Playing the source (☞ page 17 – 22).

2 [Operations with the remote control unit]
Press **SURROUND ◀** or **SURROUND ▶** to select the surround decoder to play back multichannel sound.

Select the surround mode while viewing the display on the display of this unit.

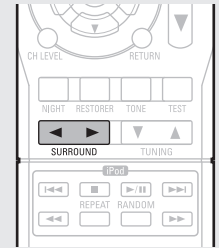

[Operations with the main unit]

Press **STANDARD** to select the surround decoder to play back multichannel sound.

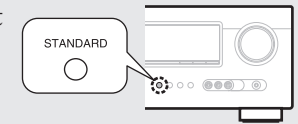

- Which decoder can be selected depends on the settings of "Speaker Config." (☞ page 7).

DOLBY PLIIx * This mode is for 7.1-channel surround playback using the surround back speakers.
 • "PLIIx Cinema", "PLIIx Music" or "PLIIx Game" is displayed.

DOLBY PLII This mode is for 5.1-channel surround playback. Select this mode if no surround back speaker is to be used.
 • "PLII Cinema", "PLII Music", "PLII Game" or "Pro Logic" is displayed.

DTS NEO:6 This mode is for 7.1-channel or 5.1-channel surround playback using the surround back speakers.
 • "DTS NEO:6 Cinema" or "DTS NEO:6 Music" is displayed.

* This can be selected when "Speaker Config." – "S.B(Pre)" (☞ page 7) is not set to "None".

3 Press **SURROUND PARAMETER** and then press **ENTER**.

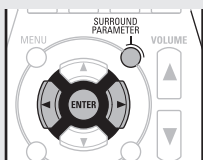

4 Use **◀▶** to select the mode according to the content to be played and then press **ENTER**.

Cinema This mode is suited for movie sources.

Music This mode is suited for music sources. More sound is sent to the front speakers than in "Cinema" mode.

Game This mode is suited for games.

Pro Logic * This mode is suitable for playback of 2-channel sources recorded with Dolby Pro Logic.

*This can be selected when "Speaker Config." - "S.B(Pre)" (page 7) is not set to "None".

5 Press **SURROUND PARAMETER**.
The menu returns to normal display.

◻ Surround playback of multi-channel sources (Dolby Digital, DTS etc.)

1 Playing the source (page 17 – 22).

2 [Operations with the remote control unit]
Press **SURROUND ◀** or **SURROUND ▶** to select the surround decoder to play back multichannel sound.

Select the surround mode while viewing the display on the display of this unit.

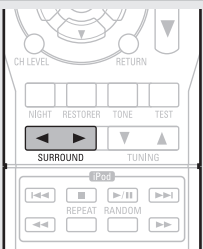

[Operations with the main unit]
Press **STANDARD** to select the surround decoder to play back multichannel sound.

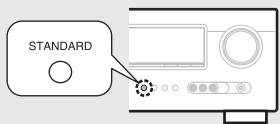

• Which decoder can be selected depends on the input signal, the settings of "Speaker Config." (page 7).

Displaying the currently playing surround mode

Input signal	Surround mode	Display
DOLBY DIGITAL (other than 2ch) / DOLBY DIGITAL EX	DOLBY DIGITAL	DOLBY DIGITAL
	DOLBY DIGITAL EX	DOLBY DIGITAL EX
	DOLBY DIGITAL + PLIIx CINEMA	DOLBY D + PLIIx C
	DOLBY DIGITAL + PLIIx MUSIC	DOLBY D + PLIIx M
DOLBY DIGITAL Plus	DOLBY DIGITAL Plus	DOLBY DIGITAL +
DOLBY TrueHD	DOLBY TrueHD	DOLBY TrueHD
DTS (5.1ch) / DTS-ES Discrete 6.1 / DTS-ES Matrix 6.1 / DTS 96/24	DTS SURROUND	DTS SURROUND
	DTS + PLIIx CINEMA	DTS + PLIIx C
	DTS + PLIIx MUSIC	DTS + PLIIx M
	DTS + NEO:6	DTS + NEO:6
	DTS ES MTRX6.1 *1	DTS ES MTRX6.1
	DTS ES DSCRT6.1 *2	DTS ES DSCRT6.1
DTS 96/24 *3	DTS 96/24	
DTS-HD	DTS-HD HI RES	DTS-HD HI RES
	DTS-HD MSTR	DTS-HD MSTR
	DTS Express	DTS Express
PCM (multi ch)	MULTI CH IN	MULTI CH IN
	MULTI IN + PLIIx CINEMA	MULTI IN +PLIIx C
	MULTI IN + PLIIx MUSIC	MULTI IN +PLIIx M
	MULTI CH IN 7.1	MULTI CH IN 7.1

*1 This is displayed when the input signal is "DTS-ES Matrix 6.1" and this unit's "AFDM" (page 37) setting is "ON".

*2 This is displayed when the input signal is "DTS-ES Discrete 6.1".

*3 This is displayed when the input signal is "DTS 96/24".

[Views on the display]

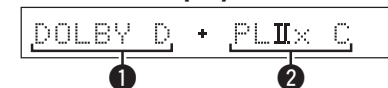

- ① Shows a decoder to be used.
 - A DOLBY DIGITAL decoder is displayed as "DOLBY D".
 - A DOLBY DIGITAL Plus decoder is displayed as "DOLBY DIGITAL +".
- ② Shows a decoder that creates sound output from the surround back speakers.



For an input signal that can be reproduced in each surround mode, see "Surround modes and surround parameters" (page 46).

Multi channel stereo playback

This mode is for enjoying stereo sound from all speakers.

1 Playing the source (👉 page 17 – 22).

2 Press **SURROUND** ◀ or **SURROUND** ▶ to select “**MULTI CH STEREO**”.

Multi channel stereo playback begins.

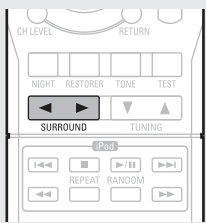

NOTE

When the input signal is Dolby TrueHD, Dolby Digital Plus, DTS-HD or DTS Express, you cannot select multi channel stereo mode.

Virtual playback

This mode is for enjoying surround effects using only the front speakers or headphones.

1 Playing the source (👉 page 17 – 22).

2 Press **SURROUND** ◀ or **SURROUND** ▶ to select “**VIRTUAL**”.

Virtual playback begins.

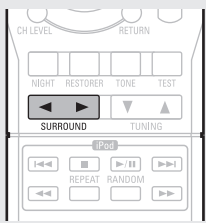

NOTE

When the input signal is Dolby TrueHD, Dolby Digital Plus, DTS-HD or DTS Express, you cannot select virtual mode.

Stereo playback

This is the mode for playing in stereo. The tone can be adjusted.

- Sound is output from the front left and right speakers and subwoofer.
- If multichannel signals are input, they are mixed down to 2-channel audio and are played.

1 Playing the source (👉 page 17 – 22).

2 Press **SURROUND** ◀ or **SURROUND** ▶ to select “**STEREO**”.

Stereo playback begins.

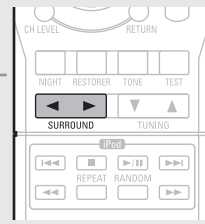

Direct playback

Sound recorded in source is played as is.

- Surround back signals are not created.
- In this mode, the following items cannot be adjusted.
 - Tone (👉 page 38)
 - RESTORER (👉 page 38)

1 Playing the source (👉 page 17 – 22).

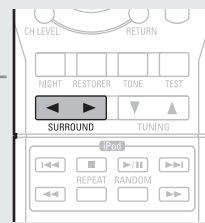

2 Press **SURROUND** ◀ or **SURROUND** ▶ to select “**DIRECT**”.

Direct playback begins.



Advanced version

Here, we explain functions and operations that let you make better use of this unit.

- **Speaker installation/connection (Other than 5.1-channel)**  **page 27**
- **Playback (Advanced operation)**  **page 29**
- **How to make detailed settings**  **page 31**

Speaker installation/connection (Other than 5.1-channel)

Here we describe the installation and connection methods for speakers other than 5.1-channel speakers. The speaker setting method is the same as "Simple version (Simple setup guide)" (page 3).

For the installation, connection and setup methods for 5.1-channel speakers, see "Simple version (Simple setup guide)" (page 3).

Procedure for speaker settings

Install

Connect (page 28)

Set up speakers (page 6)

Install



Install the surround back speakers in a position 60 to 90 cm higher than ear level.

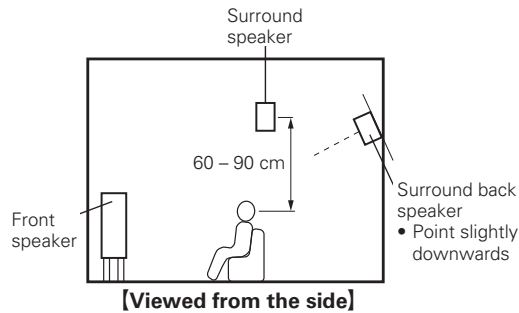

When 7.1ch (Surround back speaker) installed

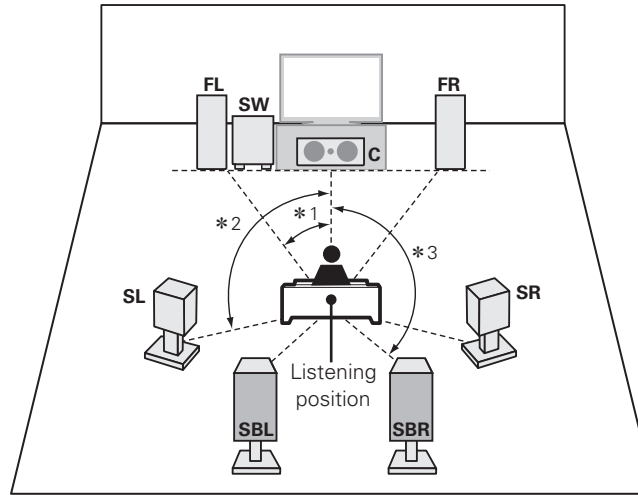

*1 22° - 30° *2 90° - 110° *3 135° - 150°

When 2.1ch installed

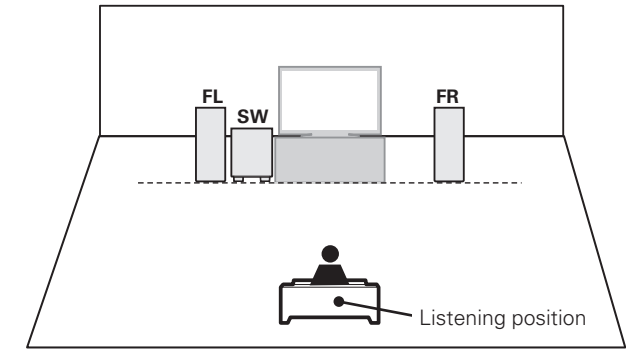

FL Front speaker (L)
FR Front speaker (R)
C Center speaker
SW Subwoofer

SL Surround speaker (L)
SR Surround speaker (R)
SBL Surround back speaker (L)
SBR Surround back speaker (R)

Connect

- For the method of connecting 5.1-channel speakers, see page 4.
- For the method of connecting the TV, see page 5.

7.1-channel (Surround back speaker) connection

- A power amplifier (sold separately) is required for this connection.

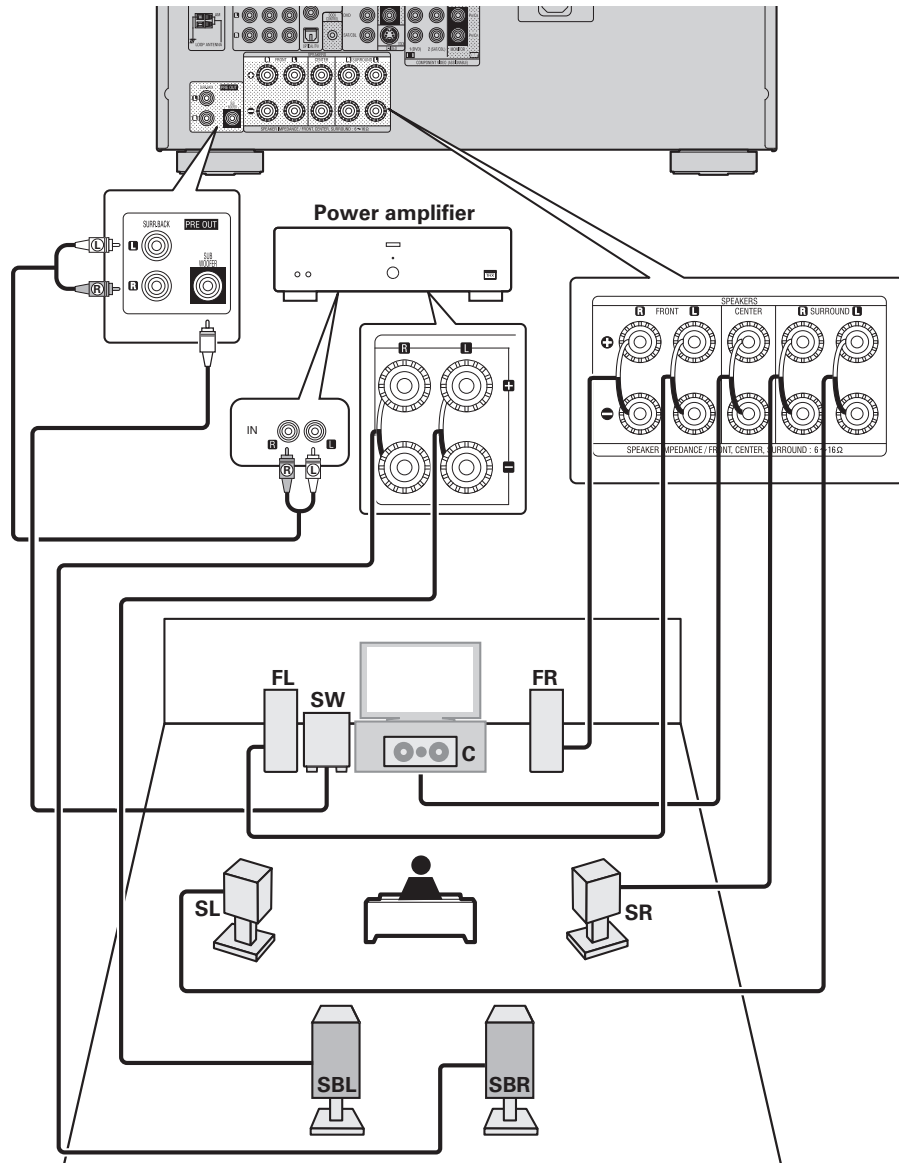

2.1-channel/2-channel connection

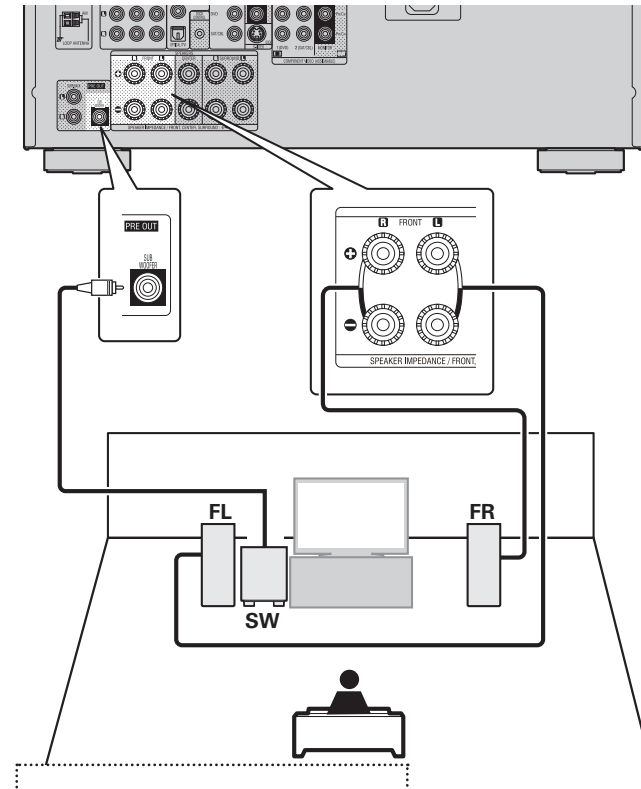

2-channel connection

For 2-channel playback, disconnect the subwoofers.

Playback (Advanced operation)

Playback (Basic operation) (👉 page 17)

Selecting a listening mode (Surround mode)
(👉 page 23)

- ❑ Adjusting the volume of the speakers (👉 page 29)
- ❑ Sleep timer function (👉 page 30)
- ❑ Quick select function (👉 page 30)
- ❑ Various memory functions (👉 page 30)

Convenient functions

Adjusting the volume of the speakers

You can adjust the channel level either according to the playback sources or to your taste, as described below.

❑ Adjusting the volume of the different speakers

1 Press CH LEVEL.

FL 4 0.0dB

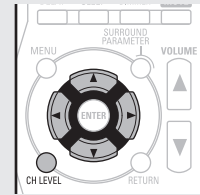

2 Use Δ / ∇ to select the speaker.

The speaker that can be set switches each time one of the buttons is pressed.

3 Use \triangleleft / \triangleright to adjust the volume.

- In the case of a subwoofer, pressing \triangleleft when it is at “-12 dB” will change the setting to “OFF”.



- If no button is operated for about 5 seconds, the display is returned to the normal display.
After registering, the display is returned to the normal display.
- When a headphone jack is inserted, the headphone channel level can be adjusted.

❑ Adjusting the volume of group of speakers (Fader function)

This function lets you adjust (fade) the sound all at once from the front (front speaker / center speaker) or rear (surround speaker / surround back speaker).

1 Press CH LEVEL.

FL 4 0.0dB

2 Press Δ .

Front4:Rear

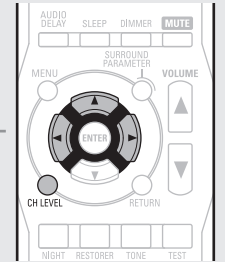

3 Use \triangleleft / \triangleright to adjust the volume of the speakers. (\triangleleft : front, \triangleright : rear)



- If no button is operated for about 5 seconds, the display is returned to the normal display.
After registering, the display is returned to the normal display.
- The fader function does not affect the subwoofer.
- The fader can be adjusted until the volume of the speaker is adjusted to the lowest value of -12 dB.

Sleep timer function

The power automatically goes into standby once the set time has elapsed.

This is convenient for playing sources while going to sleep.

Press SLEEP and display the time you want to set.

The "SLEEP" indicator on the display lights.

- The time switches as shown below each time SLEEP is pressed.



To cancel the sleep timer

Press **SLEEP** to set "OFF".

The "SLEEP" indicator on the display turns off.



- If no button is operated for about 5 seconds, the display is returned to the normal display. After registering, the display is returned to the normal display.
- The sleep timer setting is canceled if this unit's power is set to standby or turned off.

Quick select function

All of the settings in step 1 can be memorized together. By memorizing frequently used settings, you can quickly access and enjoy a playback environment that is consistently the same.

Saving the settings

1 Set the items below to the settings you want to save.

- Input source (page 17)
- Volume (page 17)
- Surround mode (page 23)
- Video Select (page 34)

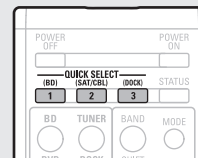

2 Press and hold the desired QUICK SELECT until "Memory" appears on the display.

The current settings will be memorized.

[Quick Select Defaults]

	Input Source	Volume
QUICK SELECT 1	BD	-40 dB
QUICK SELECT 2	SAT/CBL	-40 dB
QUICK SELECT 3	DOCK	-40 dB

Recalling the settings

Press QUICK SELECT at which the settings you want to call out are saved.

The **Q1**, **Q2** or **Q3** indicator illuminates on the display.

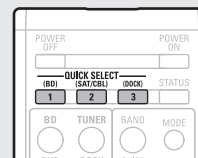

If **QUICK SELECT** on the main unit is pressed, the same function as with the remote control unit can be obtained.

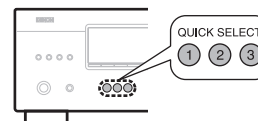

Various memory functions

Personal memory plus function

This function sets the settings (input mode, surround mode, HDMI output mode, audio delay etc.) last selected for the individual input sources.



The surround parameters, tone settings and the volumes of the different speakers are stored for the individual surround modes.

Last function memory



This function stores the settings which were made before going into the standby mode.

When the power is turned back on, the settings are restored.

How to make detailed settings

Menu map

For menu operations, see the following page.

Setting items		Number	Detailed items	Description	Page
1	Speaker Setup  Once these items are set, there is no need to set them again unless the speaker layout or the connected speakers have been changed.	1-1	Speaker Config.	Select speaker configuration and size (bass reproduction capability).	7
		1-2	Bass Setting	Set subwoofer and LFE signal range playback.	8
		1-3	Distance	Set distance from listening position to speakers.	8
		1-4	Channel Level	Set the volume of the test tone to be the same when it is output from each speaker.	9
		1-5	Crossover Freq.	Set the maximum frequency of the bass signal output from each channel to the subwoofer.	9
2	Input Setup  Displayed items of the "Input Setup" menu differs, depending on the selected input source.	2-1	Input Assign	Changes input connector assignment.	33
		2-2	Auto Preset	Uses the auto preset function to program radio stations.	34
		2-3	Preset Skip	Sets the preset memories that you do not want to display when tuning.	34
		2-4	Video Select	Makes the video settings.	34
		2-5	Input Mode	Sets the audio input mode and decode mode.	34
		2-6	Source Level	Adjusts the playback level of the audio input.	35
		2-7	Playback Mode	Makes settings for iPod playback.	35
3	Option Setup	3-1	Volume Control	Sets the volume setting.	35
		3-2	Other Setup	Makes various other settings.	36
A-1	Surround Parameter		Adjusts surround sound parameters.	36	
A-2	Tone		Adjusts the tonal quality of the sound.	38	
A-3	NIGHT MODE		Optimized setting for late-night listening. Compress dynamic range (difference between loud and soft sounds).	38	
A-4	RESTORER		Uncompresses compressed sources and apply bass boost for richer sound.	38	
A-5	Audio Delay		Compensates for incorrect timing between video and audio.	38	

Examples of front display

Below we describe typical examples of displays on the set's display window.

	Front Display	Description
Top menu display		<ol style="list-style-type: none"> 1 The number of the current selected setting menu is displayed. 2 The currently selected item is displayed on the display. Use Δ ∇ to move to the item you want to set.
Display when changing settings		<ol style="list-style-type: none"> 1 The number of the current selected setting menu is displayed. 2 Use Δ ∇ to move to the item you want to set. 3 \leftarrow \rightarrow is displayed at the sides of item whose setting can be changed. Use \leftarrow \rightarrow to change to the desired setting. 4 Press ENTER to set to the mode in which the setting can be made. 5 Press RETURN to return to the previous menu.
Display when resetting		<ol style="list-style-type: none"> 1 The number of the current selected setting menu is displayed. 2 Press ∇ to select "Default", then press ENTER to set.

Input Setup

Perform settings related to input source playback.
You do not have to change the settings to use the unit. Make settings when needed.

Menu operation

- 1** Press **MENU**.
The menu is displayed on the display of this unit.
- 2** Use Δ ∇ to select “Input Setup”, and then press **ENTER**.
- 3** Use Δ ∇ to select the menu to be set or operated, and then press **ENTER**.
- 4** Use Δ ∇ to register the settings or use \triangleleft \triangleright to change the settings.
 - To return to the previous item, press **RETURN**.
 - Exiting the Menu, press **MENU** while the menu is displayed.
The menu returns to normal display.

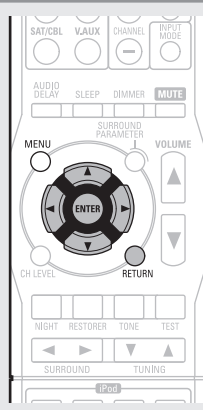

Items that can be set with the “Input Setup” procedure

- Input Assign (👉 page 33)
- Auto Preset (👉 page 34)
- Preset Skip (👉 page 34)
- Video Select (👉 page 34)
- Input Mode (👉 page 34)
- Source Level (👉 page 35)
- Playback Mode (👉 page 35)

Important information

❑ About the display of input sources

In this section, the configurable input sources for each item are shown as follows.



Input Assign

Default settings are underlined.

Input assignments menu operations

- 1** Use Δ ∇ to select the menu you want to set.
- 2** Use \triangleleft \triangleright to select the input connector to be assigned.
- 3** Press **ENTER** to enter the setting.

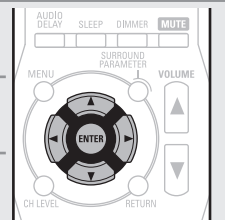

NOTE

If all “Digital” assignment of the TV source are set to “None”, TV source cannot be selected with the input source selection.

Setting items	Setting details																																					
Opt (Optical) Set this to change the optical (digital) input connectors assigned to the input sources.	OFF : Select when an optical input connector is not to be used. • At time of purchase, the settings of the different input sources are as shown below.																																					
<table border="1"> <tr> <td>BD</td> <td>DVD</td> <td>TV</td> <td>SAT/CBL</td> <td>GAME</td> <td>V.AUX</td> <td>DOCK</td> </tr> <tr> <td colspan="2">SAT/CBL</td> <td colspan="2">GAME</td> <td colspan="3"></td> </tr> <tr> <td colspan="2">V.AUX</td> <td colspan="2">DOCK</td> <td colspan="3"></td> </tr> </table>	BD	DVD	TV	SAT/CBL	GAME	V.AUX	DOCK	SAT/CBL		GAME					V.AUX		DOCK					<table border="1"> <tr> <th>Input source</th> <td>BD</td> <td>DVD</td> <td>TV</td> <td>SAT/CBL</td> <td>GAME</td> <td>V.AUX</td> <td>DOCK</td> </tr> <tr> <th>Default setting</th> <td>-</td> <td>-</td> <td>Opt</td> <td>-</td> <td>-</td> <td>-</td> <td>-</td> </tr> </table>	Input source	BD	DVD	TV	SAT/CBL	GAME	V.AUX	DOCK	Default setting	-	-	Opt	-	-	-	-
BD	DVD	TV	SAT/CBL	GAME	V.AUX	DOCK																																
SAT/CBL		GAME																																				
V.AUX		DOCK																																				
Input source	BD	DVD	TV	SAT/CBL	GAME	V.AUX	DOCK																															
Default setting	-	-	Opt	-	-	-	-																															
Coax (Coaxial) Set this to change the coaxial (digital) input connectors assigned to the input sources.	OFF : Select when a coaxial input connector is not to be used. • At time of purchase, the settings of the different input sources are as shown below.																																					
<table border="1"> <tr> <td>BD</td> <td>DVD</td> <td>TV</td> <td>SAT/CBL</td> <td>GAME</td> <td>V.AUX</td> <td>DOCK</td> </tr> <tr> <td colspan="2">SAT/CBL</td> <td colspan="2">GAME</td> <td colspan="3"></td> </tr> <tr> <td colspan="2">V.AUX</td> <td colspan="2">DOCK</td> <td colspan="3"></td> </tr> </table>	BD	DVD	TV	SAT/CBL	GAME	V.AUX	DOCK	SAT/CBL		GAME					V.AUX		DOCK					<table border="1"> <tr> <th>Input source</th> <td>BD</td> <td>DVD</td> <td>TV</td> <td>SAT/CBL</td> <td>GAME</td> <td>V.AUX</td> <td>DOCK</td> </tr> <tr> <th>Default setting</th> <td>-</td> <td>-</td> <td>-</td> <td>Coax</td> <td>-</td> <td>-</td> <td>-</td> </tr> </table>	Input source	BD	DVD	TV	SAT/CBL	GAME	V.AUX	DOCK	Default setting	-	-	-	Coax	-	-	-
BD	DVD	TV	SAT/CBL	GAME	V.AUX	DOCK																																
SAT/CBL		GAME																																				
V.AUX		DOCK																																				
Input source	BD	DVD	TV	SAT/CBL	GAME	V.AUX	DOCK																															
Default setting	-	-	-	Coax	-	-	-																															



Setting items	Setting details																
<p>Component Set this to change the component video input connectors assigned to the input sources.</p> <div style="display: flex; flex-wrap: wrap; gap: 5px;"> <div style="border: 1px solid black; padding: 2px;">BD</div> <div style="border: 1px solid black; padding: 2px;">DVD</div> <div style="border: 1px solid black; padding: 2px;">TV</div> <div style="border: 1px solid black; padding: 2px;">SAT/CBL</div> <div style="border: 1px solid black; padding: 2px;">GAME</div> <div style="border: 1px solid black; padding: 2px;">V.AUX</div> <div style="border: 1px solid black; padding: 2px;">DOCK</div> </div>	<p>Comp1/Comp2 (Component video) OFF : Select when a component video input connectors are not to be used.</p> <ul style="list-style-type: none"> At time of purchase, the settings of the different input sources are as shown below. <table border="1" style="width: 100%; text-align: center;"> <tr> <td>Input source</td> <td>BD</td> <td>DVD</td> <td>TV</td> <td>SAT/CBL</td> <td>GAME</td> <td>V.AUX</td> <td>DOCK</td> </tr> <tr> <td>Default setting</td> <td>–</td> <td>Comp1</td> <td>–</td> <td>Comp2</td> <td>–</td> <td>–</td> <td>–</td> </tr> </table> <p> Even if a component input connector is assigned to the input source "DOCK", "DOCK" is effective when a control dock for iPod is connected.</p>	Input source	BD	DVD	TV	SAT/CBL	GAME	V.AUX	DOCK	Default setting	–	Comp1	–	Comp2	–	–	–
Input source	BD	DVD	TV	SAT/CBL	GAME	V.AUX	DOCK										
Default setting	–	Comp1	–	Comp2	–	–	–										
<p>Default The "Input Assign" settings are returned to the default settings.</p>	<p>Yes : Reset to the defaults. No : Do not reset to the defaults.</p> <p> If you select "Default" and press ENTER, the message "Default?" is displayed. Select "Yes" or "No", and then press ENTER.</p>																

Auto Preset

Use the auto preset function to program radio stations.

Setting items	Setting details
<p>Start Start the auto preset process.</p> <div style="border: 1px solid black; padding: 2px; width: fit-content;">TUNER</div>	<p>Press ENTER to start "Auto Preset".</p> <p></p> <ul style="list-style-type: none"> Press RETURN or MENU to return to the setting menu without "Auto Preset". If an FM station cannot be preset automatically, select the desired station by tuning it in manually, then preset it manually.

Preset Skip

Default settings are underlined.

Set the preset memory block (from A to G) you do not want to display.

Setting items	Setting details
<p>Block A – Block G Select a block to be skipped from among preset blocks (from A to G).</p> <div style="border: 1px solid black; padding: 2px; width: fit-content;">TUNER</div>	<p>ON : Display the selected preset memory block. Skip : Do not display the selected preset memory block.</p>

Video Select

Default settings are underlined.

Set the source video.

Setting items	Setting details
<p>Video Select Video of another input source is played back combined with the playing audio.</p>	<p>Source : Play the picture and sound of the input source. DVD / SAT/CBL / V.AUX / DOCK : Select video input source to view. This can be set for individual input sources.</p> <p>NOTE It is not possible to select HDMI input signals.</p>

Input Mode

Default settings are underlined.

The input modes available for selection may vary depending on the input source.

Setting items	Setting details
<p>Input Set the audio input modes for the different input sources.</p>	<p>Auto : Automatically detect input signal and perform playback. HDMI : Play only signals from HDMI input. Digital : Play only signals from digital input (OPTICAL/COAXIAL). Analog : Play only signals from analog input.</p> <p></p> <ul style="list-style-type: none"> If an input source is "BD", "GAME" or "DOCK", "Digital" can be selected by assigning "Input Assign" (page 33) to "Opt" or "Coax" (Selectable items differ depending on the input source.) If an input source is "TU", the setting is fixed to "Digital". If the input source is set to "BD", "TV" or "Game", it cannot be set to "Analog". When digital signals are properly input, the DIG. indicator lights on the display. If the DIG. indicator does not light, check the digital input connector assignment and the connections. Buttons on the remote control unit can be used for operations. Each time INPUT MODE is pressed, the setting is changed as shown below. <div style="text-align: center;"> </div> <div style="text-align: center; margin-top: 10px;"> <p>Auto → HDMI → Digital → Analog</p> </div>



Input Setup

Setting items	Setting details
Decode Set the decode mode for input source. <div style="display: flex; justify-content: space-between; margin-top: 5px;"> BD DVD TV </div> <div style="display: flex; justify-content: space-between; margin-top: 5px;"> SAT/CBL DOCK </div> <div style="display: flex; justify-content: space-between; margin-top: 5px;"> GAME V.AUX </div>	Auto : Detect type of digital input signal and decode and play automatically. PCM : Decode and play only PCM input signals. DTS : Decode and play only DTS input signals.  <ul style="list-style-type: none"> This item can be set for input sources for which "Opt" or "Coax" is assigned at "Input Assign" (page 33). This item can be set for HDMI input sources (BD, DVD, SAT/CBL or GAME). Normally set this mode to "Auto". Set "PCM" and "DTS" when inputting the corresponding input signal.

Source Level

Default settings are underlined.

- This function corrects the playback level of the selected input source's audio input.
- Make this setting if there are differences in the input volume levels between the different sources.

Setting details

-12dB - +12dB (0dB)

 The analog input level and digital input level can be adjusted independently for input sources for which "OPT" or "COAX" is assigned at "Input Assign" (page 33).

Playback Mode

This item can be set when the input source is "DOCK".

Setting items	Setting details
Repeat Make settings for repeat mode.	All : All files are played repeatedly. One : A file being played is played repeatedly. OFF : Repeat playback mode is canceled.
Shuffle Make settings for shuffle mode.	<input type="checkbox"/> When DENON control dock for iPod ASD-11R is connected Songs : All files are played in shuffle playback mode. Albums : Files in the album are played in shuffle playback mode. OFF : Shuffle playback mode is canceled. <input type="checkbox"/> When DENON control dock for iPod ASD-3N, ASD-3W, ASD-51N or ASD-51W is connected ON : Shuffle playback mode is enabled. OFF : Shuffle playback mode is canceled.



Option Setup

Make various option settings.

Volume Control

Default settings are underlined.

Sets the volume setting.

Setting items	Setting details
Disp. (Volume Display) Set how volume is displayed.	Relative : Display --dB (Min), in the range -80.5 dB - 18 dB. Absolute : Display in the range 0 (Min) - 99.  The "Volume Display" setting is applied also to the "Volume Limit" and "Power On Level" display method.
Limit (Volume Limit) Make a setting for maximum volume.	OFF : Do not set a maximum volume. <u>-20dB (61) / -10dB (71) / 0dB (81)</u>  If "Disp." is set to "Absolute", the value in () is displayed.
P.On (Power On Level) Define the volume setting that is active when the power is turned on.	Last : Use the memorized setting from the last session. <u>--- (0)</u> : Always use the muting on condition when power is turned on. -80dB - +18dB (1 - 99) : The volume is adjusted to the set level.
Mute (Mute Level) Set the amount of attenuation when muting is on.	Full : The sound is muted entirely. -40dB : The sound is attenuated by 40 dB down. -20dB : The sound is attenuated by 20 dB down.

Remote control operation buttons



Move the cursor (Up/Down/Left/Right)



Confirm the setting



Return to previous menu

Other Setup

Default settings are underlined.

Make various other settings.

Setting items	Setting details
Audio Out Select HDMI audio output device.	Amp : Play back through speakers connected to the receiver. TV : Play back through TV connected to the receiver. If "TV" is selected, only an HDMI audio signal is output from the TV.
Auto Surr. (Auto Surround Mode) Make setting for memorizing surround mode setting for each input signal type.	ON : Memorize settings. Automatically play with the last used surround mode. OFF : Do not memorize settings. Surround mode does not change according to input signal. The auto surround mode function lets you store in the memory the surround mode last used for playing the four types of input signals listed below. <ol style="list-style-type: none"> ① Analog and PCM 2-channel signals ② Dolby Digital and DTS 2-channel signals ③ Dolby Digital and DTS multi-channel signals ④ LPCM Multi-channel signals
Display Adjust the display brightness of this unit.	Bright : Normal display brightness. Dim : Reduced display brightness. Dark : Very low display brightness. OFF : Turns the display off. Buttons on the main unit can be used for operations. Each time DIMMER is pressed, the setting is changed as shown below. <div style="text-align: center;"> <p>→ Bright → Dim → Dark → OFF → Bright</p> </div>
Setup Lock Protect settings from inadvertent change.	ON : Turn protection on. OFF : Turn protection off. To release "Setup Lock", hold MENU pressed until "Setup Lock ON" appears on the display. <p>NOTE</p> When "Setup Lock" is set to "ON", the settings listed below can no longer be changed. Also, "Setup Lock!" is displayed if you attempt to operate related settings. <ul style="list-style-type: none"> · Menu operations · Channel Level · RESTORER

Adjusting the sound field effects

The sound being played in the surround mode can be adjusted to your liking. The items (parameters) that can be adjusted depend on the signal being input and the currently set surround mode. For details on the adjustable parameters, see "Surround modes and surround parameters" (page 46).

Items that can be set with the audio adjust procedure

- Surround Parameter (page 36)
- Tone (page 38)
- NIGHT MODE (page 38)
- RESTORER (page 38)
- Audio Delay (page 38)

Surround Parameter

Default settings are underlined.

Adjust surround sound parameters. It may not be possible to set this item depending on the input signal.

Surround parameter menu operations

- 1 Press **SURROUND PARAMETER** and then press **ENTER**. The menu is displayed on the display of this unit.

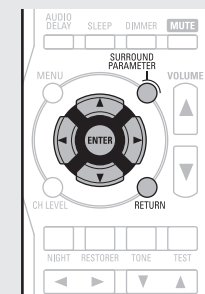
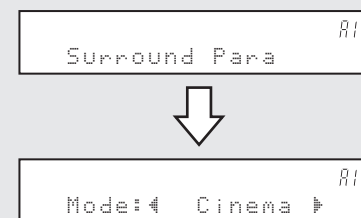

- 2 Use **Δ**/**∇** to select the mode according to the playback content.

- 3 Use **◀**/**▶** to select an item to be set and then press **ENTER** to enter the setting.

- To return to the previous item, press **RETURN**.
- Exiting the Menu, press **SURROUND PARAMETER** while the menu is displayed. The menu returns to normal display.



Adjusting the sound field effects

Setting items	Setting details
Mode Set the play modes for the different surround modes.	<input type="checkbox"/> In the PLIIx or PLII mode Cinema : Surround sound mode optimized for movie sources. Music : Surround sound mode optimized for music sources. Game : Surround sound mode optimized for games. Pro Logic : Dolby Pro Logic playback mode (PLII mode only). <input type="checkbox"/> In the DTS NEO:6 mode Cinema : Surround sound mode optimized for movie sources. Music : Surround sound mode optimized for music sources. The "Music" mode is also effective for movie sources including a lot of stereo music.
LFE Adjust the low-frequency effects level (LFE).	-10dB - 0dB For proper playback of the different sources, we recommend setting to the values below. <ul style="list-style-type: none"> • Dolby Digital sources : "0dB" • DTS movie sources : "0dB" • DTS music sources : "-10dB"
Center Image Assign center channel signal to front left and right channels for wider sound.	0.0 - 1.0 (0.3)
Panorama Assign front L/R signal also to surround channels for wider sound.	ON : Set. OFF : Do not set.
Dimension Shift sound image center to front or rear to adjust playback balance.	0 - 6 (3)
Center Width Assign center channel signal to front left and right channels for wider sound.	0 - 7 (3)
AFDM (Auto flag detect mode) Detect the source's surround back channel signal and set the optimum surround mode automatically.	ON : Set. OFF : Do not set. [Example] Playing Dolby Digital software (with EX flag) <ul style="list-style-type: none"> • When "AFDM" is set to "ON", the surround mode is automatically set to the DOLBY D + PLIIx C mode. • To play in the DOLBY DIGITAL EX mode, set "AFDM" to "OFF" and "Surround Parameter" - "SB CH OUT" to "MTRX ON". Some Dolby Digital EX sources do not include EX flags. If the playback mode does not switch automatically even when "AFDM" is set to "ON", set "Surround Parameter" - "SB CH OUT" to "MTRX ON" or "PLIIx CINEMA".

Setting items	Setting details
D.Comp Compress dynamic range (difference between loud and soft sounds).	Low / Mid / High : These set the compression level. OFF : Turn dynamic range compression off.
DRC Compress dynamic range (difference between loud and soft sounds).	Auto : Automatic dynamic range compression on/off control according to the source. This can be set in the Dolby TrueHD mode. Low / Mid / High : These set the compression level. OFF : Dynamic range compression is always off.
SB CH OUT Sets the method of generating of the surround back channel. This can also be set by pressing STANDARD on the main unit.	<input type="checkbox"/> For 2-channel sources ON : The surround back channel is used. OFF : No signal is played from the surround back channels. <input type="checkbox"/> For Multi-channel sources Set the decoding method for the surround back channel. DSCRT ON : Play the surround back signals included in the 7.1-channel source. MTRX ON : Generate and play the surround back signals from the surround channel signals. ES MTRX *1 : Generate and play the surround back signals from the surround channel signals of the DTS source. ES DSCRT *2 : Play the surround back signals included in the 6.1-channel DTS source. PLIIx CINEMA *3 : Generate and play the surround back signals by decoding the signals in the Dolby Pro Logic IIx Cinema mode. PLIIx MUSIC : Generate and play the surround back signals by decoding the signals in the Dolby Pro Logic IIx Music mode. OFF : Do not play the surround back channel. *1 This can be selected when playing DTS sources. *2 This can be selected when playing DTS sources including a signal to identify discrete 6.1-channel signals. *3 This can be selected when "Speaker Config." - "S.B(Pre)" (page 7) is set to other than "None". If the source being played contains a surround back signal, the decoder type is automatically selected by the AFDM function. Set "AFDM" to "OFF" to switch to your preferred decoder.
NOTE If the setting in "Speaker Config." - "S.B(Pre)" (page 7) is "None", "SB CH OUT" is not displayed.	
Subwoofer Turn subwoofer output on and off.	ON : The subwoofer is used. OFF : The subwoofer is not used. NOTE This can be set when the surround mode is "DIRECT" (page 46, 47), and the "Mode" (page 8) is "LFE+Main".
Default The "Surround Parameter" settings are returned to the default settings.	Yes : Reset to the defaults. No : Do not reset to the defaults.

Simple version

Basic version

Advanced version

Information

Remote control operation buttons



Move the cursor (Up/Down/Left/Right)



Confirm the setting



Return to previous menu

- If no button is operated for about 5 seconds, the display is returned to the normal display. After registering, the display is returned to the normal display.

Tone

Default settings are underlined.

Adjust the tonal quality of the sound.

1 Press **TONE**.

ToneControl 1 OFF

2 Use $\triangleleft \triangleright$ to select "ON".

ON : Allow tone adjustment (bass, treble).

OFF : Playback without tone adjustment.

NOTE

The tone cannot be adjusted in the direct mode.

3 Press **TONE** to select an item to be set, and use $\triangleleft \triangleright$ to select a setting value.

Bass : Adjust low frequency range (bass).

• **-6dB - +6dB (0dB)**

Treble : Adjust high frequency range (treble).

• **-6dB - +6dB (0dB)**

"Bass" or "Treble" can be set when "Tone Control" is set to "ON".

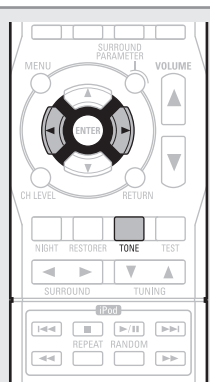

NIGHT MODE

Default settings are underlined.

Optimized setting for late-night listening.

Press **NIGHT** to select your desired mode.

D. COMP : OFF

OFF : Not set.

Low : Set the adjusted value to "Low".

Mid : Set the adjusted value to "Middle".

High : Set the adjusted value to "High".



When a Dolby TrueHD signal is output, "DRC" is displayed on the display of the main unit.

The setting mode is also changed as shown below.

• **OFF** : Not set.

• **Low** : Set the adjusted value to "Low".

• **Mid** : Set the adjusted value to "Middle".

• **High** : Set the adjusted value to "High".

• **Auto** : Automatic dynamic range compression on/off control according to the source.

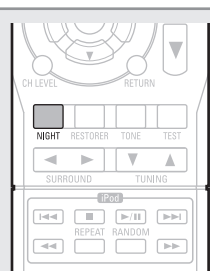

RESTORER

Compressed audio formats such as MP3, WMA (Windows Media Audio) and MPEG-4 AAC reduce the amount of data by eliminating signal components that are hard for the human ear to hear. The RESTORER function generates the signals eliminated upon compression, restoring the sound to conditions near those of the original sound before compression. It also corrects the sense of volume of the bass to obtain richer sound with compressed audio signals.

Press **RESTORER** to select "ON" or "OFF".

RESTORER : ON

ON : Use RESTORER.

OFF : Do not use RESTORER.



- This item can be set with analog signals or when a PCM signal (fs = 44.1/48 kHz) is input.
- This cannot be set when the surround mode is set to "DIRECT".
- This item default setting for "iPod" is "ON". All others are set to "OFF".
- When set to "ON", **RSTR** is displayed.

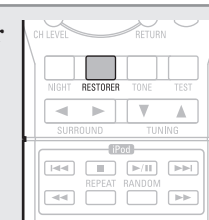

Audio Delay

Default settings are underlined.

While viewing video, manually adjust the time to delay audio output.

1 Press **AUDIO DELAY**.

A. Delay : 0ms

2 Use $\triangleleft \triangleright$ to select the value to be set and then press **ENTER** to enter the setting.

0ms - 200ms

Store "Audio Delay" for each input source.

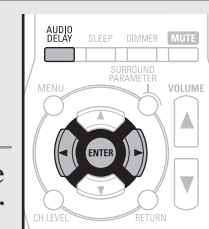

Information

Information on the main unit's various settings (Status) and on input signals (Audio Input Signal) is shown on the display.

The information displayed changes each time you press **STATUS**.

The information is displayed for several seconds before the display returns to its original condition.

[Items to be checked]

- Input source
- Surround mode
- Input digital terminal
- Input mode
- Decode mode
- Video select
- Dialogue normalization
- etc.



NOTE

The information displayed differs according to the input source.

Dialogue normalization function

This function is automatically activated when playing Dolby Digital sources.

It automatically corrects the standard signal level for individual program sources.





The correction value can be checked using **STATUS**.

Offset - 4dB

The figure is the corrected value. This cannot be changed.

Information

Here, we list various information related to this unit.
Please refer to this information as needed.

- Part names and functions  page 41
- Other information  page 45
- Troubleshooting  page 51
- Specifications  page 53
- Index  page 54

Part names and functions

Front panel

For buttons not explained here, see the page indicated in parentheses ().

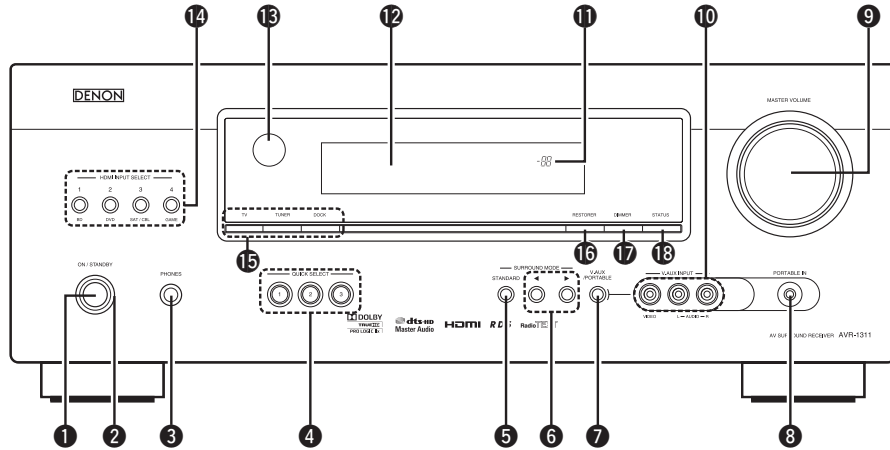

- 1 Power operation button (ON/STANDBY)** (6, 10)
Turns power to this unit on and off (standby).
- 2 Power indicator** (10)
- 3 Headphones jack (PHONES)**
When the headphones are plugged into this jack, audio will no longer be output from the connected speakers or from the PRE OUT connectors.
- NOTE**
To prevent hearing loss, do not raise the volume level excessively when using headphones.
- 4 QUICK SELECT buttons** (30)
- 5 STANDARD button** (23, 24, 37)
- 6 SURROUND MODE buttons** (23, 53)
- 7 V.AUX/PORTABLE button** (17)
- 8 PORTABLE jack** (15)
- 9 MASTER VOLUME control knob** (17)

- 10 V.AUX INPUT connectors** (15)
Remove the cap covering the connectors when you want to use them.

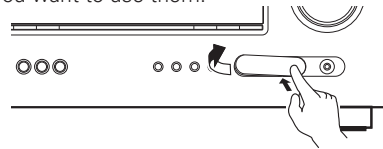

- 11 Master volume indicator** (17)
- 12 Display** (41)
- 13 Remote control sensor** (44)
- 14 HDMI INPUT SELECT buttons** (17)
- 15 Input source select buttons** (17, 18, 20)
- 16 RESTORER button** (38)
- 17 DIMMER button** (36)
- 18 STATUS button** (18, 39)

Display

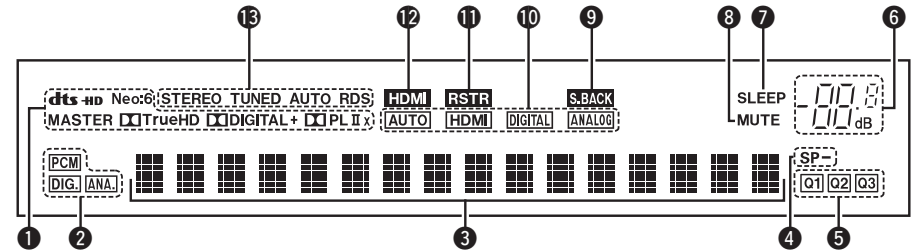

- 1 Decoder indicators**
These light when the respective decoders are operating.
- 2 Input signal indicators**
- 3 Information display**
The input source name, surround mode, setting values and other information are displayed here.
- 4 Front speaker indicator**
This lights when audio signals are being output from the speakers.
- 5 QUICK SELECT indicators**
The indicator corresponding to the memory for which Quick Select function is set, lights ("Quick select function" (page 30)).
- 6 Master volume indicator**
When performing setting operations, displays the menu number.
- 7 Sleep timer indicator**
This lights when the sleep mode is selected (page 30).
- 8 MUTE indicator**
This lights when the mute mode is selected (page 17).
- 9 Surround back indicator**
This lights when audio signals are being output from the surround back speakers (page 7).
- 10 Input mode indicators**
Set the audio input modes for the different input sources (page 34).
- 11 RESTORER indicator**
This lights when the RESTORER mode is selected (page 38).
- 12 HDMI indicator**
This lights when playing using HDMI connections.
- 13 Tuner reception mode indicators**
These light according to the reception conditions when the input source is set to "TUNER".
STEREO: In the FM mode, this lights when receiving analog stereo broadcasts.
TUNED: This lights when the broadcast is properly tuned in.
AUTO: This lights when in the auto tuning mode.
RDS: This light when receiving RDS broadcasts.

Rear panel

See the page indicated in parentheses ().

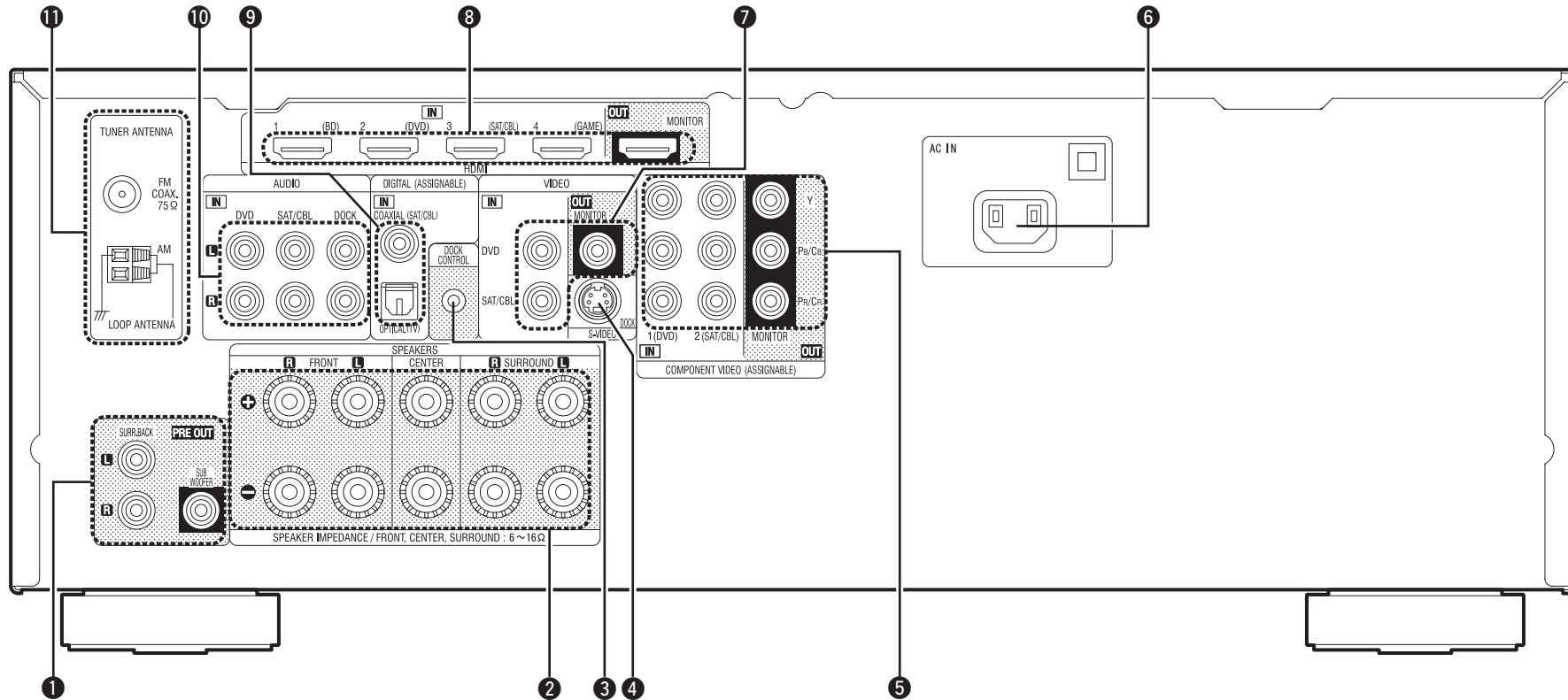

- | | |
|---|---|
| ① PRE OUT connectors (5, 28) | ⑦ VIDEO connectors (13, 14) |
| ② Speaker terminals (5, 28) | ⑧ HDMI connectors (12) |
| ③ DOCK CONTROL jack (16) | ⑨ Digital audio connectors (13, 14) |
| ④ S-VIDEO connector (16) | ⑩ Analog audio connectors (14, 16) |
| ⑤ COMPONENT VIDEO connectors (13, 14) | ⑪ FM/AM antenna terminals (16) |
| ⑥ AC inlet (AC IN) (5) | |

NOTE

Do not touch the inner pins of the connectors on the rear panel. Electrostatic discharge may cause permanent damage to the unit.

Remote control unit

For buttons not explained here, see the page indicated in parentheses ().

Simple version

Basic version

Advanced version

Information

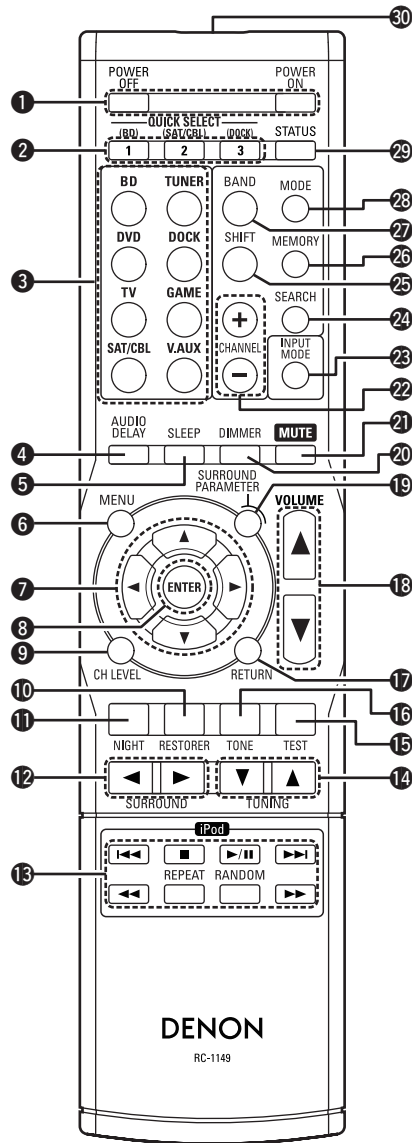

- 1 **Power buttons (POWER ON / OFF)** (6, 10)
- 2 **QUICK SELECT buttons** (30)
- 3 **Input source select buttons** (17, 18, 20)
- 4 **AUDIO DELAY button** (38)
- 5 **Sleep timer button (SLEEP)** (30)
- 6 **MENU button** (6, 9, 33, 36)
- 7 **Cursor buttons (▲▼◀▶)** (6 – 9, 18, 29, 32 – 38)
- 8 **ENTER button** (6 – 9, 18, 32 – 38)
- 9 **Channel level button (CH LEVEL)** (29)
- 10 **RESTORER button** (38)
- 11 **NIGHT button** (38)
- 12 **SURROUND buttons (◀▶)** (23 – 25)
- 13 **iPod system buttons** (18)
 - Skip buttons (◀◀, ▶▶)
 - Play/Pause button (▶/||)
 - Stop button (■)
 - Search buttons (◀◀, ▶▶)
 - Repeat playback button (REPEAT)
 - Random playback button (RANDOM)
- 14 **TUNING buttons (▲▼)** (20)
- 15 **TEST button** (9)
- 16 **TONE button** (38)
- 17 **RETURN button** (6, 32 – 34, 36)
- 18 **Master volume control buttons (VOLUME ▲▼)** (17)
- 19 **SURROUND PARAMETER button** (24, 36)
- 20 **DIMMER button** (36)
- 21 **Muting button (MUTE)** (17)
- 22 **Channel buttons (CHANNEL +, -)** (20)
- 23 **INPUT MODE button** (34)
- 24 **SEARCH button** (18, 19)
- 25 **SHIFT button** (20)
- 26 **MEMORY button** (20)
- 27 **BAND button** (20)
- 28 **MODE button** (20)
- 29 **STATUS button** (18, 39)
- 30 **Remote control signal transmitter** (44)

Inserting the batteries

① Remove the rear lid in the direction of the arrow and remove it.

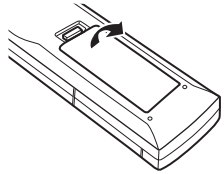

② Load the two batteries properly as indicated by the marks in the battery compartment.

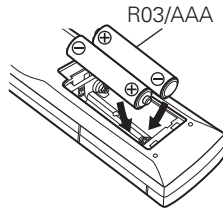

③ Put the rear cover back on.

NOTE

- Insert the specified batteries in the remote control unit.
- Replace the batteries with new ones if the set does not operate even when the remote control unit is operated close to the unit. (The supplied batteries are only for verifying operation.)
- When inserting the batteries, be sure to do so in the proper direction, following the ⊕ and ⊖ marks in the battery compartment.
- To prevent damage or leakage of battery fluid:
 - Do not use a new battery together with an old one.
 - Do not use two different types of batteries.
 - Do not attempt to charge dry batteries.
 - Do not short-circuit, disassemble, heat or dispose of batteries in flames.
 - Do not keep the battery in a place exposed to direct sunlight or in places with extremely high temperatures, such as near a heater.
- If the battery fluid should leak, carefully wipe the fluid off the inside of the battery compartment and insert new batteries.
- Remove the batteries from the remote control unit if it will not be in use for long periods.
- Used batteries should be disposed of in accordance with the local regulations regarding battery disposal.

Operating range of the remote control unit

Point the remote control unit at the remote sensor when operating it.

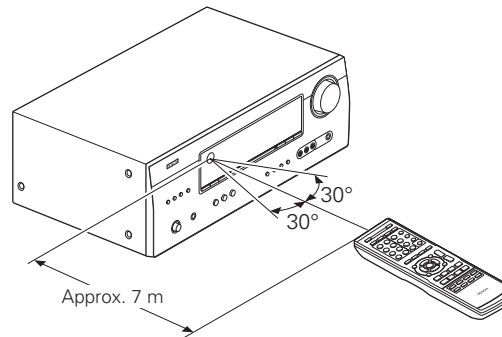

NOTE



The set may function improperly or the remote control unit may not operate if the remote control sensor is exposed to direct sunlight, strong artificial light from an inverter type fluorescent lamp or infrared light.

Other information

- ❑ **Trademark information** (👉 page 45)
- ❑ **Surround** (👉 page 46)
- ❑ **Explanation of terms** (👉 page 50)

Trademark information

This product uses the following technologies:

	<p>Manufactured under license from Dolby Laboratories. "Dolby", "Pro Logic" and the double-D symbol are trademarks of Dolby Laboratories.</p>
	<p>Manufactured under license under U.S. Patent #'s: 5,451,942; 5,956,674; 5,974,380; 5,978,762; 6,226,616; 6,487,535; 7,212,872; 7,333,929; 7,392,195; 7,272,567 & other U.S. and worldwide patents issued & pending. DTS and the Symbol are registered trademarks, & DTS-HD, DTS-HD Master Audio, and the DTS logos are trademarks of DTS, Inc. Product includes software. © DTS, Inc. All Rights Reserved.</p>
	<p>HDMI, the HDMI Logo and High-Definition Multimedia Interface are trademarks or registered trademarks of HDMI Licensing LLC in the United States and other countries.</p>

Surround

This unit is equipped with a digital signal processing circuit that lets you play program sources in the surround mode to achieve the same sense of presence as in a movie theater.

Surround modes and surround parameters

This table shows the speakers that can be used in each surround mode and the surround parameters adjustable in each surround mode.

Symbols in the table

- This indicates the audio output channels or surround parameters that can be set.
- ◎ This indicates the audio output channels. The output channels depend on the settings of "Speaker Config." (page 7).

Surround mode (page 23)	Channel output					Surround Parameter (page 36)			
	Front L/R	Center	Surround L/R	Surround Back L/R	Subwoofer	Mode (page 37)	D. Comp * 3 (page 37)	DRC * 4 (page 37)	LFE * 5 (page 37)
DIRECT (2channel)	○				◎ * 2		○	○	
DIRECT (Multi-channel)	○	◎	◎	◎ * 1	◎		○	○	○
STEREO	○				◎		○	○	○
MULTI CH IN	○	◎	◎	◎	◎				○
DOLBY PRO LOGIC IIx	○	◎	◎	◎	◎	○	○	○	
DOLBY PRO LOGIC II	○	◎	◎		◎	○	○	○	
DTS NEO:6	○	◎	◎	◎	◎	○	○	○	
DOLBY DIGITAL	○	◎	◎	◎	◎		○		○
DOLBY DIGITAL Plus	○	◎	◎	◎	◎		○		○
DOLBY TrueHD	○	◎	◎	◎	◎				○
DTS SURROUND	○	◎	◎	◎	◎		○		○
DTS 96/24	○	◎	◎	◎	◎		○		○
DTS-HD	○	◎	◎	◎	◎		○		○
DTS Express	○	◎	◎	◎	◎		○		○
MULTI CH STEREO	○	◎	◎	◎	◎		○		○
VIRTUAL	○				◎ * 2		○		○

- * 1 A signal for each channel contained in an input signal is output as audio.
- * 2 Only when "Mode" is set to "LFE+Main" (page 8), sound is output from the subwoofer.
- * 3 This item can be selected when a Dolby Digital or DTS signal is played.
- * 4 This item can be selected when a Dolby TrueHD signal is played.
- * 5 This item can be selected when a Dolby Digital or DTS signal or DVD-Audio is played.

Surround mode (page 23)	Surround Parameter (page 36)							Tone (page 38)	RESTORER * 7 (page 38)
	AFDM * 6 (page 37)	S.Back (page 37)	Subwoofer (page 37)	PRO LOGIC II/IIx Music mode only			NEO:6 Music mode only		
				Panorama (page 37)	Dimension (page 37)	CenterWidth (page 37)	CenterImage (page 37)		
DIRECT (2 channel)			○ * 2						
DIRECT (Multi-channel)									
STEREO								○	○
MULTI CH IN	○	○						○	
DOLBY PRO LOGIC IIx		○		○	○	○		○	○
DOLBY PRO LOGIC II		○		○	○	○		○	○
DTS NEO:6		○					○	○	○
DOLBY DIGITAL	○	○						○	
DOLBY DIGITAL Plus	○	○						○	
DOLBY TrueHD	○	○							
DTS SURROUND	○	○						○	
DTS 96/24	○	○						○	
DTS-HD	○	○							
DTS Express	○	○						○	
MULTI CH STEREO		○						○	○
VIRTUAL								○	○

- * 2 Only when "Mode" is set to "LFE+Main" (page 8), sound is output from the subwoofer.
- * 6 This item can be selected when a Dolby Digital or DTS or DVD-Audio signal is played.
- * 7 This item can be set when the input signal is analog, PCM 48 kHz or 44.1 kHz.

Simple version

Basic version

Advanced version

Information

Types of input signals, and corresponding surround modes

This table shows the input signal that can be played in each surround mode. Check the audio signal of the input source then select the surround mode.

Symbols in the table

- This indicates the default surround mode.
- ⊙ This indicates the surround mode that is fixed when "AFDM" (page 37) is set to "ON".
- This indicates the selectable surround mode.

Surround mode (page 23)	NOTE	Input signal types and formats																
		ANALOG	PCM		DTS-HD		DTS					DOLBY		DOLBY DIGITAL				
			LINEAR PCM (multi ch)	LINEAR PCM (2ch)	DTS-HD Master Audio	DTS-HD High Resolution Audio	DTS EXPRESS	DTS ES DSCRT (With Flag)	DTS ES MTRX (With Flag)	DTS (5.1ch)	DTS 96/24	DOLBY TrueHD	DOLBY DIGITAL Plus	DOLBY DIGITAL EX (With Flag)	DOLBY DIGITAL EX (With no Flag)	DOLBY DIGITAL (5.1/5/4ch)	DOLBY DIGITAL (4/3ch)	DOLBY DIGITAL (2ch)
DTS SURROUND																		
DTS-HD MSTR					●													
DTS-HD HI RES					●													
DTS ES DSCRT6.1	*							● ⊙										
DTS ES MTRX6.1	*							● ⊙										
DTS SURROUND								○	○	●								
DTS 96/24											●							
DTS + PLIIx CINEMA	*							○	○	○	○							
DTS + PLIIx MUSIC	*							○	○	○	○							
DTS EXPRESS								●										
DTS + NEO:6	*								○	○	○							
DTS NEO:6 CINEMA		○		○													○	
DTS NEO:6 MUSIC		○		○													○	
DOLBY SURROUND																		
DOLBY TrueHD													●					
DOLBY DIGITAL+													●					
DOLBY DIGITAL EX	*													○	○	○	○	
DOLBY DIGITAL														○	●	●	●	
DOLBY (D) +PLIIx CINEMA	*													● ⊙	○	○	○	
DOLBY (D) +PLIIx MUSIC	*													○	○	○	○	
DOLBY PRO LOGIC IIx CINEMA	*	○		○													○	
DOLBY PRO LOGIC IIx MUSIC	*	○		○													○	
DOLBY PRO LOGIC IIx GAME	*	○		○													○	
DOLBY PRO LOGIC II CINEMA		○		○													○	
DOLBY PRO LOGIC II MUSIC		○		○													○	
DOLBY PRO LOGIC II GAME		○		○													○	
DOLBY PRO LOGIC		○		○													○	

* If "Speaker Config." – "S.B(Pre)" (page 7) is set to "None", this surround mode cannot be selected.

Surround mode (page 23)	NOTE	Input signal types and formats																
		ANALOG	PCM		DTS-HD		DTS					DOLBY		DOLBY DIGITAL				
			LINEAR PCM (multi ch)	LINEAR PCM (2ch)	DTS-HD Master Audio	DTS-HD High Resolution Audio	DTS EXPRESS	DTS ES DSCRT (With Flag)	DTS ES MTRX (With Flag)	DTS (5.1ch)	DTS 96/24	DOLBY TrueHD	DOLBY DIGITAL Plus	DOLBY DIGITAL EX (With Flag)	DOLBY DIGITAL EX (With no Flag)	DOLBY DIGITAL (5.1/5/4ch)	DOLBY DIGITAL (4/3ch)	DOLBY DIGITAL (2ch)
MULTI CH IN																		
MULTI CH IN			●															
MULTI CH IN + PLIIx CINEMA	*		○															
MULTI CH IN + PLIIx MUSIC	*		○															
MULTI CH IN 7.1			● ◎ (7.1)															
DIRECT																		
DIRECT		○	○	○	○	○	○	○	○	○	○	○	○	○	○	○	○	○
DSP SIMULATION																		
MULTI CH STEREO		○	○	○				○	○	○	○			○	○	○	○	○
VIRTUAL		○	○	○				○	○	○	○			○	○	○	○	○
STEREO																		
STEREO		●	○	●	○	○	○	○	○	○	○	○	○	○	○	○	○	○

* If "Speaker Config." – "S.B(Pre)" (page 7) is set to "None", this surround mode cannot be selected.

Explanation of terms

A

Adobe RGB color / Adobe YCC601 color

Like x.v.Color, each of these color spaces defines a palette of available colors that is larger than the traditional RGB color model.

D

Deep Color

This technology allows expression of more number of colors than the conventional 8 bits and can reproduce colors close to natural ones without color streak.

Dolby Digital

Dolby Digital is a multi-channel digital signal format developed by Dolby Laboratories.

A total of 5.1 channels are played: 3 front channels ("FL", "FR" and "C"), 2 surround channels ("SL" and "SR") and the "LFE" channel for low frequencies.

Because of this, there is no crosstalk between channels and a realistic sound field with a "three-dimensional" feeling (sense of distance, movement and positioning) is achieved.

A realistic, powerful sense of presence is achieved when playing movie sources in AV rooms as well.

Dolby Digital EX

Dolby Digital EX is a 6.1-channel surround format proposed by Dolby Laboratories that allows users to enjoy in their homes the "DOLBY DIGITAL SURROUND EX" audio format jointly developed by Dolby Laboratories and Lucas Films.

The 6.1 channels of sound, including surround back channels, provide improved sound positioning and expression of space.

Dolby Digital Plus

Dolby Digital Plus is an improved Dolby Digital signal format that is compatible with up to 7.1 channels of discrete digital sound and also improves sound quality thanks to extra data bit rate performance. It is upwardly compatible with conventional Dolby Digital, so it offers greater flexibility in response to the source signal and the conditions of the playback equipment.

Dolby TrueHD

Dolby TrueHD is a high definition audio technology developed by Dolby Laboratories, using lossless coding technology to faithfully reproduce the sound of the studio master.

This format provides the facility to support up to 8 audio channels with a sampling frequency of

96kHz/24bit resolution and up to 6 audio channels with a sampling frequency of 192kHz/24bit resolution. Dolby TrueHD is adopted for applications that put very high importance on sound quality.

Dolby Pro Logic II

Dolby Pro Logic II is a matrix decoding technology developed by Dolby Laboratories.

Regular music such as that on CDs is encoded into 5 channels to achieve an excellent surround effect. The surround channel signals are converted into stereo and full band signals (with a frequency response of 20 Hz to 20 kHz or greater) to create a "three-dimensional" sound image offering a rich sense of presence for all stereo sources.

Dolby Pro Logic IIx

Dolby Pro Logic IIx is a further improved version of the Dolby Pro Logic II matrix decoding technology. Audio signals recorded in 2 channels are decoded to achieve a natural sound with up to 7.1 channels. There are three modes: "Music" suited for playing music, "Cinema" suited for playing movies, and "Game" which is optimized for playing games.

Downmix

This function converts the number of channels of surround audio to less number of channels and plays back.

DTS

This is an abbreviation of Digital Theater System, which is a digital audio system developed by DTS. When playing back audio by connecting this system with a device such as DTS amplifier, accurate sound field position and realistic sound effect as if you are in a movie theater can be obtained.

DTS 96/24

DTS 96/24 is a digital audio format enabling high sound quality playback in 5.1 channels with a sampling frequency of 96 kHz and 24 bit quantization on DVD-Video.

DTS Digital Surround

DTS Digital Surround is the standard digital surround format of DTS, Inc., compatible with a sampling frequency of 44.1 or 48 kHz and up to 5.1 channels of digital discrete surround sound.

DTS-ES™ Discrete 6.1

DTS-ES™ Discrete 6.1 is a 6.1-channel discrete digital audio format adding a surround back (SB) channel to the DTS digital surround sound.

Decoding of conventional 5.1-channel audio signals is also possible according to the decoder.

DTS-ES™ Matrix 6.1

DTS-ES™ Matrix 6.1 is a 6.1-channel discrete digital audio format inserting a surround back (SB) channel to the DTS digital surround sound through matrix encoding. Decoding of conventional 5.1-channel audio signals is also possible according to the decoder.

DTS Express

DTS Express is an audio format supporting low bit rates (max. 5.1 channels, 24 to 256 kbps).

DTS-HD

This audio technology provides higher sound quality and enhanced functionality than the conventional DTS and is adopted as an optional audio for Blu-ray Disc. This technology supports multi-channel, high data transfer speed, high sampling frequency, and lossless audio playback. Maximum 7.1-channels are supported in Blu-ray Disc.

DTS-HD High Resolution Audio

DTS-HD High Resolution Audio is an improved version of the conventional DTS, DTS-ES and DTS 96/24 signals formats, compatible with sampling frequencies of 96 or 48 kHz and up to 7.1 channels of discrete digital sound. High data bit rate performance provides high quality sound. This format is fully compatible with conventional products, including conventional DTS digital surround 5.1-channel data.

DTS-HD Master Audio

DTS-HD Master Audio is a lossless audio format created by Digital Theater System (DTS). This format provides the facility to support up to 8 audio channels with a sampling frequency of 96kHz/24bit resolution and up to 6 audio channels with a sampling frequency of 192kHz/24bit resolution. It is fully compatible with conventional products, including conventional DTS digital surround 5.1-channel data.

DTS NEO:6™ Surround

DTS NEO:6™ is a matrix decoding technology for achieving 6.1-channel surround playback with 2-channel sources. It includes "DTS NEO:6 Cinema" suited for playing movies and "DTS NEO:6 Music" suited for playing music.

Dynamic range

The difference between the maximum undistorted sound level and the minimum discernible level above the noise emitted by the device.

H

HDCP

When transmitting digital signals between devices, this copyright protection technology encrypts the signals to prevent content from being copied without authorization.

HDMI

This is an abbreviation of High-Definition Multimedia Interface, which is an AV digital interface that can be connected to a TV or amplifier. Video signal and audio signal can be connected using 1 cable.

L

LFE

This is an abbreviation of Low Frequency Effect, which is an output channel that emphasizes low frequency effect sound. Surround audio is intensified by outputting 20 Hz to 120 Hz deep bass.

M

MP3 (MPEG Audio Layer-3)

This is an internationally standardized audio data compression scheme, using the "MPEG-1" video compression standard. It compresses the data volume to about one eleventh its original size while maintaining sound quality equivalent to a music CD.

MPEG (Moving Picture Experts Group), MPEG-2, MPEG-4

These are the names for digital compression format standards used for the encoding of video and audio. Video standards include "MPEG-1 Video", "MPEG-2 Video", "MPEG-4 Visual", "MPEG-4 AVC". Audio standards include "MPEG-1 Audio", "MPEG-2 Audio", "MPEG-4 AAC".

P

Protection Circuit

This is a function to prevent damage to components within the power supply when an abnormality such as an overload, excess voltage occurs or temperature for any reason.

In this unit, the power indicator blinks and the unit enters standby mode when an abnormality occurs.

S

Sampling frequency

Sampling involves taking a reading of a sound wave (analog signal) at regular intervals and expressing the height of the wave at each reading in digitized format (producing a digital signal).

Explanation of terms

The number of readings taken in one second is called the "sampling frequency". The larger the value, the closer the reproduced sound is to the original.

Speaker impedance

This is an AC resistance value, indicated in Ω (ohms). Greater power can be obtained with this value smaller.

sYCC601 color

Like x.v.Color, each of these color spaces defines a palette of available colors that is larger than the traditional RGB color model.

W**WMA (Windows Media Audio)**

This is audio compression technology developed by Microsoft Corporation.

WMA data can be encoded using Windows Media® Player Ver.7, 7.1, Windows Media® Player for Windows® XP and Windows Media® Player 9 Series.

To encode WMA files, only use applications authorized by Microsoft Corporation. If you use an unauthorized application, the file may not work properly.

X**x.v.Color**

This function lets HDTVs display colors more accurately. It enables display with natural, vivid colors. "x.v.Color" is a Sony registered trademark.

Troubleshooting

If a problem should arise, first check the following:

1. Are the connections correct?
2. Is the set being operated as described in the owner's manual?
3. Are the other components operating properly?

If this unit does not operate properly, check the items listed in the table below. Should the problem persist, there may be a malfunction.

In this case, disconnect the power immediately and contact your store of purchase.

[General]

Symptom	Cause/Solution	Page
Power does not turn on.	<ul style="list-style-type: none"> • Check whether the power plug is correctly inserted into the power outlet. • The protection circuit is active. Disconnect the power plug from the electric outlet, wait 5 to 10 seconds and then insert it back into the outlet. 	5 4, 50
Display is off.	<ul style="list-style-type: none"> • Set "Display" on the menu to something other than "OFF". 	36
The power indicator is blinking red in intervals of approximately 2 seconds.	<ul style="list-style-type: none"> • The temperature inside the unit has risen. Please turn off power once, and re-apply the power after the temperature has fallen sufficiently. • Please re-install this unit in a place having good ventilation. 	- -
The power indicator is blinking red in intervals of approximately 0.5 seconds.	<ul style="list-style-type: none"> • Please use speakers which have the specified impedance. • The speaker cable has shorted (is touching). Firmly twist the core wire in the speaker cable, and then re-connect it to the speaker terminal. 	4 4
After turning on the power, the power indicator is blinking red in intervals of approximately 0.5 seconds.	<ul style="list-style-type: none"> • This unit amplifier circuit has failed. Turn off the power and please contact the DENON service adviser. 	-
Set does not operate properly.	<ul style="list-style-type: none"> • Reset the microprocessor. 	53

[Video]

Symptom	Cause/Solution	Page
No picture appears.	<ul style="list-style-type: none"> • Check the TV connection. • Set the TV input correctly. 	5 6

[Audio]

Symptom	Cause/Solution	Page
Audio is not output.	• Check the connections for all devices.	5, 12 – 16
	• Check the speaker connections.	5, 28
	• Check whether the audio device power is turned on.	6
	• Adjust the master volume.	17
	• Cancel the mute mode.	17
	• Select a suitable input source.	17
	• Select a suitable input mode.	34
	• Disconnect the headphones. No sound is output from the speakers or the PRE OUT connectors when headphones are connected.	41
No sound is produced from surround speaker.	• Check if the surround speakers are connected to the SURROUND terminals.	–
No sound is produced from surround back speaker.	• Set "Speaker Config." – "S.B(Pre)" on the menu to something other than "None".	7
	• Set "Surround Parameter" – "SB CH OUT" on the menu to something other than "OFF".	37
	• Set the surround mode to something other than "STEREO".	23
No sound is produced from subwoofer.	• Check the subwoofer connections.	5, 28
	• Turn on the subwoofer's power.	6
	• Set "Speaker Config." – "SW" on the menu to "Yes".	7
	• If "Front" and "Center" for "Speaker Config." are set to "Large", and "Mode" is set to "LFE", no sound may be output from the subwoofers, depending on the input signal or selected surround mode.	7, 8
DTS sound is not output.	• Set "Decode" on the menu to "Auto" or "DTS".	35
Dolby TrueHD, DTS-HD, Dolby Digital Plus audio is not output.	• Make HDMI connections.	12

[HDMI]

Symptom	Cause/Solution	Page
No audio is output with HDMI connection.	• Check the connection of the HDMI connectors.	12
	• When outputting HDMI audio from the speakers, set "Audio Out" on the menu to "Amp".	36
	• When outputting HDMI audio from a TV, set "Audio Out" on the menu to "TV".	36
No video is output with HDMI connection.	• Check the connection of the HDMI connectors.	12
	• Set the input source to match the connected HDMI connector.	12, 17
	• Check whether the TV is compatible with copyright protection (HDCP). If connected to a device not compatible with HDCP, video will not be output correctly.	12

[Radio]

Symptom	Cause/Solution	Page
Reception fails, or there is a lot of noise or distortion.	• Change the antenna orientation or position.	16
	• Separate the AM loop antenna from the unit.	16
	• Use an FM outdoor antenna.	16
	• Separate the antenna from other connection cables.	16

[iPod]

Symptom	Cause/Solution	Page
iPod cannot be played.	• Check the iPod connections.	16
	• Plug the control dock for iPod's AC adapter into a power outlet.	–
	• Switch the input source to "DOCK".	17
"Connection Error" is displayed.	• Unable to communicate properly. Turn off the power to this unit, disconnect the iPod and then reconnect it.	–
"Not Support" is displayed.	• The iPod connected to the unit is not compatible. Please make sure the iPod you are connecting is compatible.	–
	• The software version of the connected iPod is an old one. Please update to the latest version.	–
"Connection Error" is displayed.	• The iPod is not responding. Turn off the power to this unit, disconnect the iPod and then reconnect it.	–

[Remote control unit]

Symptom	Cause/Solution	Page
The set cannot be operated with the remote control unit.	• Batteries are worn out. Replace with new batteries.	44
	• Operate the remote control unit within a distance of about 7 m from this unit and at an angle of within 30°.	44
	• Remove any obstacle between this unit and the remote control unit.	44
	• Insert the batteries in the proper direction, checking the ⊕ and ⊖ marks.	44
	• The set's remote control sensor is exposed to strong light (direct sunlight, inverter type fluorescent bulb light, etc.). Move the set to a place in which the remote control sensor will not be exposed to strong light.	44

Resetting the microprocessor

Perform this procedure if the display is abnormal or if operations cannot be performed. When the microprocessor is reset, all the settings are reset to their default values.

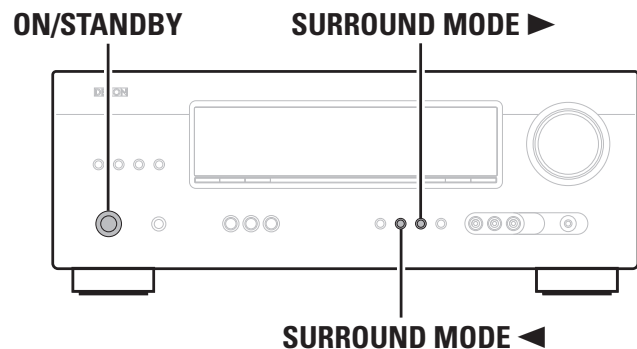

1 Turn off the power using **ON/STANDBY**.

2 Press **ON/STANDBY** while simultaneously pressing **SURROUND MODE** ◀ and **SURROUND MODE** ▶.

3 Once the display starts flashing at intervals of about 1 second, release the two buttons.



If in step 3 the display does not flash at intervals of about 1 second, start over from step 1.

Specifications

□ Audio section

- Power amplifier
- Rated output:

Front:
75 W + 75 W (8 Ω, 20 Hz – 20 kHz with 0.08 % T.H.D.)
110 W + 110 W (6 Ω, 1 kHz with 0.7 % T.H.D.)

Center:
75 W (8 Ω, 20 Hz – 20 kHz with 0.08 % T.H.D.)
110 W (6 Ω, 1 kHz with 0.7 % T.H.D.)

Surround:
75 W + 75 W (8 Ω, 20 Hz – 20 kHz with 0.08 % T.H.D.)
110 W + 110 W (6 Ω, 1 kHz with 0.7 % T.H.D.)
6 – 16 Ω

Output connectors:

- Analog

Input sensitivity/Input impedance:

Frequency response:

S/N:

200 mV/47 kΩ
10 Hz – 100 kHz — +1, –3 dB (DIRECT mode)
98 dB (IHF–A weighted, DIRECT mode)

□ Video section

- Standard video connectors

Input/output level and impedance:

Frequency response:

- Color component video connector

Input/output level and impedance:

1 V_{p-p}, 75 Ω
5 Hz – 10 MHz — +1, –3 dB

Y (brightness) signal — 1 V_{p-p}, 75 Ω
P_B / C_B signal — 0.7 V_{p-p}, 75 Ω
P_R / C_R signal — 0.7 V_{p-p}, 75 Ω
5 Hz – 60 MHz — +0, –3 dB

Frequency response:

□ Tuner section

[FM]

[AM]

(Note: μV at 75 Ω, 0 dBf = 1 × 10⁻¹⁵ W)

Receiving Range:

Usable Sensitivity:

50 dB Quietening Sensitivity:

S/N (IHF-A):

Total harmonic Distortion (at 1 kHz):

87.5 MHz – 108.0 MHz	522 kHz – 1611 kHz
1.2 μV (12.8 dBf)	18 μV
MONO 2.8 μV (20.2 dBf)	
MONO 70 dB	
STEREO 67 dB	
MONO 0.7 %	
STEREO 1.0 %	

□ General

Power supply:

Power consumption:

Maximum external dimensions:

Weight:

AC 230 V, 50 Hz
330 W
Less than 0.5 W (Standby)
435 (W) × 166 (H) × 381 (D) mm
9.2 kg

□ Remote Control Unit (RC-1149)

Batteries:

Maximum external dimensions:

Weight:

R03/AAA Type (two batteries)
50 (W) × 211 (H) × 22 (D) mm
110 g (including batteries)

For purposes of improvement, specifications and design are subject to change without notice.

Index

👉 Numerics

2.1-channel 27, 28
 3D 12
 5.1-channel 4
 7.1-channel 27, 28

👉 A

Accessories 1
 Adobe RGB color / Adobe YCC601 color 50
 AFDM 37
 AM loop antenna 16
 Audio cable 5, 14, 15
 Audio Delay 38
 Audio Out 36
 Auto Preset 34
 Auto Surround Mode 36

👉 B

Bass 38
 Bass Setting 8
 Browse mode 18

👉 C

Cable
 Audio cable 5, 14, 15
 Coaxial digital cable 14
 Component video cable 13, 14
 HDMI cable 5, 12
 Optical cable 13
 Speaker cable 5
 Video cable 13, 14, 15
 Center Image 37
 Center Width 37
 Channel Level 9
 Coaxial digital cable 14
 Component video cable 13, 14
 Condensation 2
 Connection
 Antenna 16
 Blu-ray Disc player 12, 14
 Cable TV 14
 Control dock for iPod 16
 Digital camcorder 15
 DVD player 12, 14
 Game console 12
 HDMI 12
 Portable player 15
 Power cord 5
 Satellite tuner 14

Set-top box 12, 14
 Speaker 4, 28
 TV 5, 12, 13
 Crossover Freq. 9

👉 D

D.Comp 37
 Decode 35
 Deep Color 12, 50
 Dimension 37
 Display 36, 41
 Distance 8
 Dolby
 Dolby Digital 24, 50
 Dolby Digital EX 24, 50
 Dolby Digital Plus 24, 50
 Dolby Pro Logic II 50
 Dolby Pro Logic IIx 50
 Dolby TrueHD 24, 50
 Downmix 50
 DRC 37
 DTS 24, 50
 DTS 96/24 24, 50
 DTS Digital Surround 50
 DTS-ES Discrete 6.1 24, 50
 DTS-ES Matrix 6.1 24, 50
 DTS Express 50
 DTS-HD 24, 50
 DTS-HD High Resolution Audio 50
 DTS-HD Master Audio 50
 DTS NEO:6™ Surround 23, 50
 Dynamic range 50

👉 F

FM indoor antenna 16
 Front Panel 41

👉 H

HDCP 12, 50
 HDMI 12, 50
 HDMI 1.4a 12
 HDMI cable 5, 12
 Headphones 41

👉 I

Information 39
 Input Assign 33
 Input Mode 34
 Input Setup 33
 Input signal 24, 48

👉 L

LFE 37, 50
 Listening mode 23

👉 M

Menu map 31
 Mode 37
 MP3 50
 MPEG 50
 Mute Level 35

👉 N

NIGHT MODE 38

👉 O

Optical cable 13
 Option Setup 35
 Other Setup 36
 Volume Control 35
 Other Setup 36
 Audio Out 36
 Auto Surround Mode 36
 Display 36
 Setup Lock 36

👉 P

Panorama 37
 Playback
 Blu-ray Disc player 17
 Control dock for iPod 18
 Direct 25
 DVD player 17
 FM/AM broadcasts 20
 Multi channel stereo 25
 Portable player 17
 Standard 23
 Stereo 25
 Virtual 25
 Playback Mode (Control dock for iPod) 35
 Power On Level 35
 Preset Skip 34
 Presetting radio stations 20
 Protection circuit 50
 PTY 21

👉 Q

Quick select 30

👉 R

RDS 21
 Rear panel 42

Remote control unit 43
 Inserting the batteries 44
 Remote mode 18
 Repeat 35
 Resetting the microprocessor 53
 RESTORER 38
 RT 22

👉 S

Sampling frequency 50
 SB CH OUT 37
 Selecting the input source 17
 Setup Lock 36
 Shuffle 35
 Sleep timer 30
 Source Level 35
 Speaker
 Connect 4, 28
 Install 4, 27
 Set up 6
 Speaker cable 5
 Speaker Config. 7
 Speaker impedance 4, 51
 Subwoofer 37
 Surround back speaker 27, 28
 Surround Mode 23, 46
 Surround Parameter 36
 sYCC601 color 51

👉 T

Tone 38
 TP 22
 Trademark 45
 Treble 38
 Turn off power (standby) 10
 Turn on power 6

👉 V

Video 34
 Video cable 13, 14, 15
 Video Select 34
 Volume Control 35
 Volume Limit 35

👉 W

WMA 51

👉 X

x.v.Color 51







DENON

www.denon.com

D&M Holdings Inc.
Printed in China 5411 10486 002D